

# Panasonic®

## DVD System Operating Instructions

Model No. **SC-MT1**

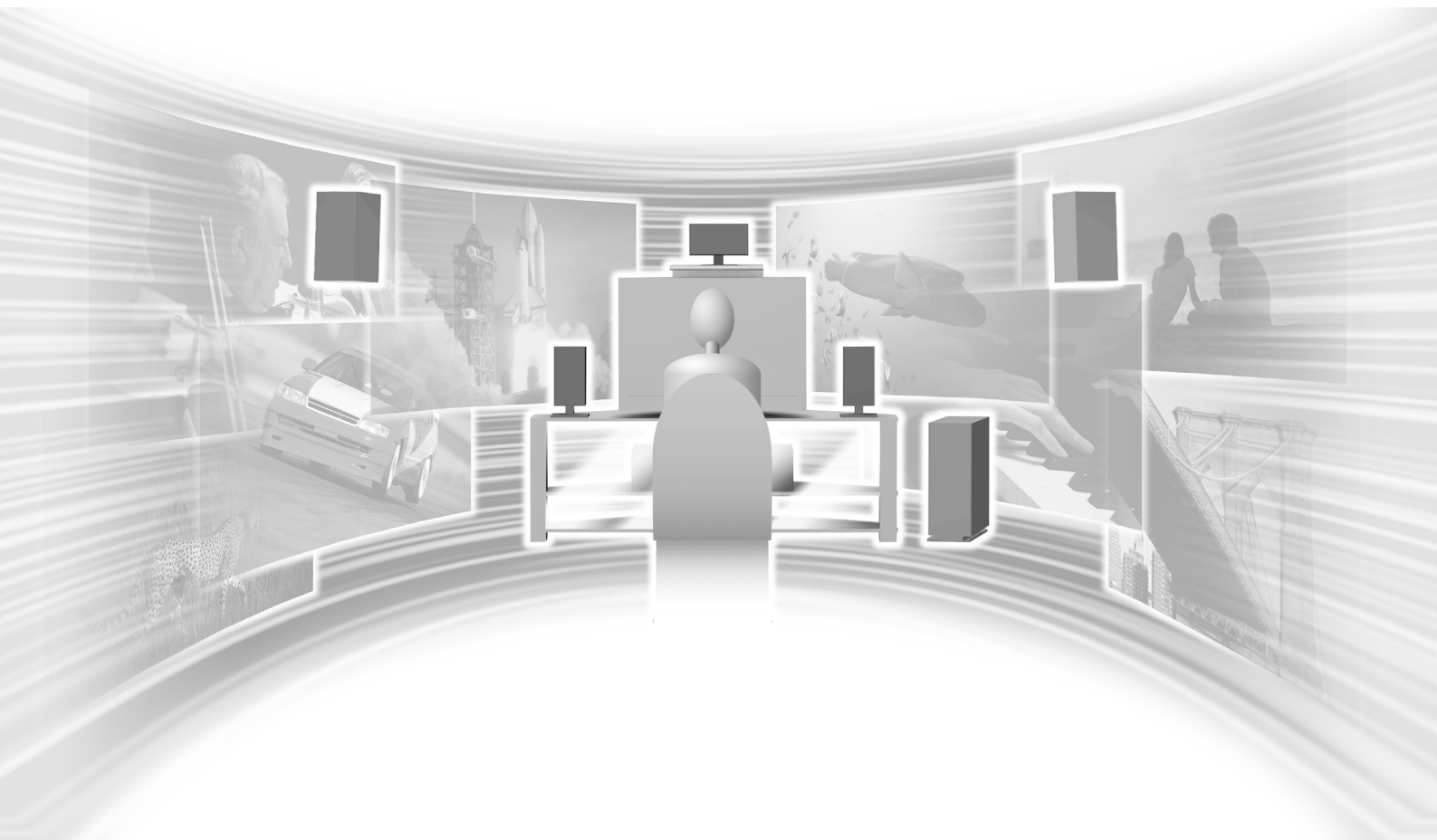
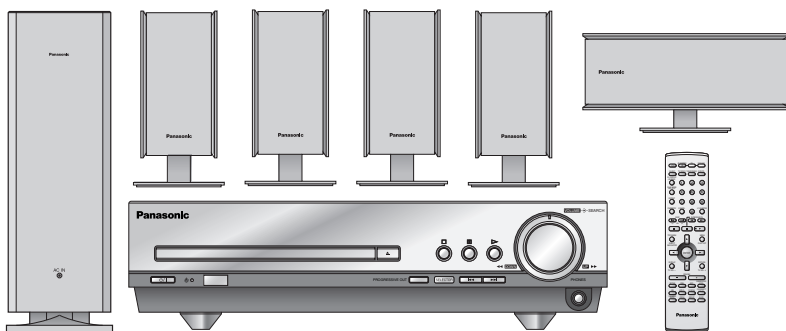

Before connecting, operating or adjusting this product, please read these instructions completely. Please keep this manual for future reference.

### Region number supported by this player

Region numbers are allocated to DVD players and software according to where they are sold.

- The region number of this player is "1".
- The player will play DVD-Video marked with labels containing "1" or "ALL".

Example:



For U.S.A. only

The warranty can be found on page 39.

# Dear customer

Thank you for purchasing this product.  
For optimum performance and safety, please read these instructions carefully.

Operations in these instructions are described mainly with the remote control, but you can do the operations on the main unit if the controls are the same.

<b>System</b>	SC-MT1
<b>Main unit</b>	SA-MT1
<b>Front and surround speakers</b>	SB-FS801A
<b>Center speaker</b>	SB-PC700
<b>Active subwoofer</b>	SB-WA340

Getting started

## CAUTION!

**THIS PRODUCT UTILIZES A LASER.**  
**USE OF CONTROLS OR ADJUSTMENTS OR PERFORMANCE OF PROCEDURES OTHER THAN THOSE SPECIFIED HEREIN MAY RESULT IN HAZARDOUS RADIATION EXPOSURE.**  
**DO NOT OPEN COVERS AND DO NOT REPAIR YOURSELF. REFER SERVICING TO QUALIFIED PERSONNEL.**

## WARNING:

**TO REDUCE THE RISK OF FIRE, ELECTRIC SHOCK OR PRODUCT DAMAGE, DO NOT EXPOSE THIS APPARATUS TO RAIN, MOISTURE, DRIPPING OR SPLASHING AND THAT NO OBJECTS FILLED WITH LIQUIDS, SUCH AS VASES, SHALL BE PLACED ON THE APPARATUS.**

## CAUTION:

**TO PREVENT ELECTRIC SHOCK MATCH WIDE BLADE OF PLUG TO WIDE SLOT, FULLY INSERT.**

## CAUTION!

**DO NOT INSTALL OR PLACE THIS UNIT IN A BOOKCASE, BUILT-IN CABINET OR IN ANOTHER CONFINED SPACE. ENSURE THE UNIT IS WELL VENTILATED. TO PREVENT RISK OF ELECTRIC SHOCK OR FIRE HAZARD DUE TO OVERHEATING, ENSURE THAT CURTAINS AND ANY OTHER MATERIALS DO NOT OBSTRUCT THE VENTILATION VENTS.**



**CAUTION:** TO REDUCE THE RISK OF ELECTRIC SHOCK, DO NOT REMOVE SCREWS. NO USER-SERVICEABLE PARTS INSIDE. REFER SERVICING TO QUALIFIED SERVICE PERSONNEL.



The lightning flash with arrowhead symbol, within an equilateral triangle, is intended to alert the user to the presence of uninsulated "dangerous voltage" within the product's enclosure that may be of sufficient magnitude to constitute a risk of electric shock to persons.



The exclamation point within an equilateral triangle is intended to alert the user to the presence of important operating and maintenance (servicing) instructions in the literature accompanying the appliance.

<b>CAUTION</b>	- LASER RADIATION WHEN OPEN. DO NOT STARE INTO BEAM. FDA 21 CFR / Class II
<b>CAUTION</b>	- VISIBLE AND INVISIBLE LASER RADIATION WHEN OPEN. AVOID EXPOSURE TO BEAM. IEC60825-1 / Class 3b
<b>WARNING</b>	- SYNLIG OCH OSYNLIG LASERSTRÅLNING NÄR DENNA DEL ÄR ÖPPNAD. BETRÄKTA EJ STRÅLEN.
<b>ADVÄRSEL</b>	- SYNLIG OG OSYNLIG LASERSTRÅLNING VED ÅBNING. UNNGÅ UDSÆTTELSE FOR STRÅLEN.
<b>ADVÄRSEL</b>	- SYNLIG OG OSYNLIG LASERSTRÅLNING NÄR DEKSEL ÅPNET. UNNGÅ EKSPONERING FOR STRÅLEN.
<b>VARO!</b>	- AVATTAESSA OLET ALTTIINA NÄKYVÄÄ JA NÄKYMÄTÖN LASERSÄTELYLLE. ÄLÄ KATSO SÄTEESSEEN.
<b>VORSICHT</b>	- SICHTBARE UND UNSICHTBARE LASERSTRÄHLUNG, WENN ABDECKUNG GEÖFFNET. NICHT DEM STRAHL AUSSETZEN.
<b>ATTENTION</b>	- RAYONNEMENT LASER VISIBLE ET INVISIBLE EN CAS D'OUVERTURE. EXPOSITION DANGEREUSE AU FASCEAU.
<b>注意</b>	- 打开時有可见及不可见激光辐射。避免激光照射。
<b>注意</b>	- ここを開くと可視及び不可視レーザー光が出ます。ビームを見たり、触れたりしないで下さい。 ROLXS0054

(Inside of product)

**THE FOLLOWING APPLIES ONLY IN THE U.S.A.:**

## CAUTION:

This equipment has been tested and found to comply with the limits for a Class B digital device, pursuant to Part 15 of the FCC Rules.

These limits are designed to provide reasonable protection against harmful interference in a residential installation. This equipment generates, uses and can radiate radio frequency energy and, if not installed and used in accordance with the instructions, may cause harmful interference to radio communications. However, there is no guarantee that interference will not occur in a particular installation. If this equipment does cause harmful interference to radio or television reception, which can be determined by turning the equipment off and on, the user is encouraged to try to correct the interference by one or more of the following measures:

- Reorient or relocate the receiving antenna.
- Increase the separation between the equipment and receiver.
- Connect the equipment into an outlet on a circuit different from that to which the receiver is connected.
- Consult the dealer or an experienced radio/TV technician for help.

Any unauthorized changes or modifications to this equipment would void the user's authority to operate this device.

This device complies with Part 15 of the FCC Rules. Operation is subject to the following two conditions: (1) This device may not cause harmful interference, and (2) this device must accept any interference received, including interference that may cause undesired operation.

# Accessories



Please check and identify the supplied accessories. Use numbers indicated in parentheses when asking for replacement parts.

(Only for U.S.A.)

To order accessories contact 1-800-332-5368 or web site (<http://www.panasonic.com>).

(Only for Canada)

To order accessories, call the dealer from whom you have made your purchase.

- 1 Remote control (EUR7623X20)

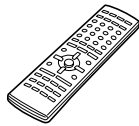

- 2 Batteries for remote control

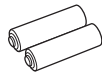

- 1 AC power supply cord (RJA0065-1D)

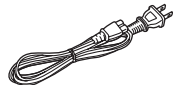

- 1 AM loop antenna (N1DAAAA00001)



- 1 FM indoor antenna (RSA0007-J)

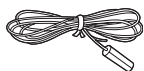

- 1 Video cable (RJL1P016815A)



- 1 System cable (K1HA25HA0001)

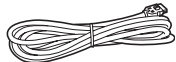

- 5 Speaker cables (RFA2163-J)  
3×4-m (13-foot) cables  
2×10-m (33-foot) cables



- 1 Antenna plug (K2RC021B0001)



- 1 Sheet of speaker-cable stickers

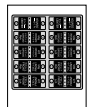

### Note

The included AC power supply cord is for use with this unit only. Do not use it with other equipment.

### User memo:

DATE OF PURCHASE _____
DEALER NAME _____
DEALER ADDRESS _____
TELEPHONE NUMBER _____

The model number and serial number of this product can be found on either the back or the bottom of the unit. Please note them in the space provided below and keep for future reference.

MODEL NUMBER \_\_\_\_\_ SC-MT1 \_\_\_\_\_

SERIAL NUMBER \_\_\_\_\_

# Table of contents

## Getting started

- Accessories . . . . . 3
- IMPORTANT SAFETY INSTRUCTIONS . . . . . 4
- Disc information . . . . . 5

### Simple setup

- STEP1 Locating . . . . . 6
- STEP2 Speakers . . . . . 7
- STEP3 Television . . . . . 8
- STEP4 Connecting the subwoofer, antennas, and AC power supply cord . . . . . 9
- STEP5 The remote control . . . . . 9
- Other speaker setup options
- STEP6 QUICK SETUP . . . . . 11

- Control reference guide . . . . . 12

## Disc operations

- Discs—Basic play . . . . . 13
  - Position Memory function . . . . . 13
  - Skipping items/Fast forward and rewind—SEARCH . . . . . 14
  - Slow-motion play/Frame-by-frame viewing . . . . . 14
- Discs—Convenient functions . . . . . 15
  - Starting play from a selected item/Repeat play . . . . . 15
  - A-B repeat play/Selecting groups to play . . . . . 15
  - All group play/Program play/Random play . . . . . 16
  - Soundtracks/Subtitles . . . . . 17
  - Marking places to play again/Variable Zoom function . . . . . 18
- WMA/MP3 and CD text navigation menus . . . . . 19
- Playing the programs or play lists on DVD-RAM . . . . . 20
  - Selecting a program to play—DIRECT NAVIGATOR . . . . . 20
  - Using the play list menu . . . . . 20
- Using On-Screen Menu Icons . . . . . 21
  - Common procedures/Progress indicator . . . . . 21
  - Disc information/Unit information . . . . . 22

## Radio operations

- The radio . . . . . 24
  - Manual tuning/Preset tuning . . . . . 24

## Sound field/sound quality operations

- Sound field . . . . . 25
  - Dolby Digital and DTS/Dolby Pro Logic . . . . . 25
  - Speaker level adjustments . . . . . 25
  - Super Surround/Sound Field Control . . . . . 26
  - Center Focus . . . . . 26
  - Custom Sound Memory—Store the sound settings . . . . . 26
- Sound quality . . . . . 27
  - Adjusting the bass . . . . . 27
  - Re-master—Enjoying more natural sound . . . . . 27

## Other functions

- Convenient functions . . . . . 28
  - Muting the volume/Dimming the display . . . . . 28
  - The sleep timer/Using headphones . . . . . 28
- Changing settings . . . . . 29
- Language code list . . . . . 31
- Optional antenna connections . . . . . 31
- Operating a television or video cassette recorder . . . . . 32

## Reference

- Glossary . . . . . 34
- Specifications . . . . . 35
- Troubleshooting guide . . . . . 36
- Product Service . . . . . 38
- Maintenance . . . . . 38
- Limited Warranty (U.S.A.) . . . . . 39









# IMPORTANT SAFETY INSTRUCTIONS

Read these operating instructions carefully before using the unit. Follow the safety instructions on the unit and the applicable safety instructions listed below. Keep these operating instructions handy for future reference.

- 1) Read these instructions.
- 2) Keep these instructions.
- 3) Heed all warnings.
- 4) Follow all instructions.
- 5) Do not use this apparatus near water.
- 6) Clean only with dry cloth.
- 7) Do not block any ventilation openings. Install in accordance with the manufacturer's instructions.
- 8) Do not install near any heat sources such as radiators, heat registers, stoves, or other apparatus (including amplifiers) that produce heat.
- 9) Do not defeat the safety purpose of the polarized or grounding-type plug. A polarized plug has two blades with one wider than the other. A grounding-type plug has two blades and a third grounding prong. The wide blade or the third prong are provided for your safety. If the provided plug does not fit into your outlet, consult an electrician for replacement of the obsolete outlet.
- 10) Protect the power cord from being walked on or pinched particularly at plugs, convenience receptacles, and the point where they exit from the apparatus.
- 11) Only use attachments/accessories specified by the manufacturer.
- 12) Use only with the cart, stand, tripod, bracket, or table specified by the manufacturer, or sold with the apparatus. When a cart is used, use caution when moving the cart/apparatus combination to avoid injury from tip-over.
- 13) Unplug this apparatus during lightning storms or when unused for long periods of time.
- 14) Refer all servicing to qualified service personnel. Servicing is required when the apparatus has been damaged in any way, such as power-supply cord or plug is damaged, liquid has been spilled or objects have fallen into the apparatus, the apparatus has been exposed to rain or moisture, does not operate normally, or has been dropped.



## Discs that can be played

Disc type	Logo	Indication used in instructions
DVD-RAM		<b>RAM</b>
DVD-Audio		<b>DVD-A</b>
DVD-Video	 	<b>DVD-V</b>
DVD-R		
Video CD		<b>VCD</b>
CD	 	<b>CD</b> Including CD text
CD-R/RW	—	<b>WMA</b> <b>MP3</b>

- Use discs with the above logos and that conform to specifications. The unit cannot play other discs correctly.
- Do not use irregularly shaped discs (e.g. heart-shaped), as these can damage the unit.

## Discs that cannot be played

PAL discs (except DVD-Audio), DVD-ROM, CD-ROM, CDV, CD-G, +RW, DVD-RW, CVD, SVCD, SACD, Divx Video Discs and Photo CD.

## Disc structure

Disc structure and the labels given to the items on discs depend on the disc type.

- Track:** the smallest division on DVD-Audio, CDs and Video CDs, or a single WMA/MP3 file.
- Chapter:** the smallest division on DVD-Video.
- Group:** collections of tracks on DVD-Audio and equivalent to folders or albums on data discs.
- Title:** the largest division on DVD-Video, usually an entire movie.
- Program:** the division on DVD-RAM equivalent to a single recording.
- Play list:** a group of scenes on DVD-RAM.
- Scene:** DVD-RAM program sections specified and grouped into play lists on a DVD video recorder.

## Playing DVDs and Video CDs

The producer of these discs can control how they are played so you may not always be able to control play as described in these operating instructions (for example if the play time is not displayed or if a Video CD has menus). Read the disc's instructions carefully.

## CD-R and CD-RW discs

This unit can play CD-R/RW (audio recording disc) recorded with CD-DA, video CD, WMA or MP3. Finalize\* the disc after recording.

## DVD-R discs

Panasonic DVD-R recorded and finalized\* on a Panasonic DVD video recorder are played as DVD-Video on this unit.

\*A process that allows play on compatible equipment.

## DVD-RAM discs

DVD-RAM discs must meet the following conditions for this unit to be able to play them.

Type	<ul style="list-style-type: none"> <li>• Non-cartridge discs</li> <li>• Discs that can be removed from their cartridges (TYPE 2 and 4)</li> </ul>
Capacity	<ul style="list-style-type: none"> <li>• 12 cm (5") 9.4 GB (double-sided) and 4.7 GB (single-sided)</li> <li>• 8 cm (3") 2.8 GB (double-sided)</li> </ul>
Recording format	Discs recorded with DVD video recorders, DVD video cameras, personal computers, etc., using Version 1.1 of the Video Recording Format (a unified video recording standard).

- Remove TYPE 2 and 4 discs from their cartridges before use, then return them when you are finished. Read the instructions for the disc carefully.
- Do not allow the disc to become dirty or scratched. Store discs in their cartridges and ensure the disc label and cartridge label face the same way.
- Some parts of the disc, for example where one program ends and another begins, may not play smoothly.

## Note

It may not be possible to play CD-R, CD-RW, DVD-R and DVD-RAM in all cases due to the type of disc or condition of the recording.

## Playing PAL system DVD-Audio

This unit converts PAL to NTSC for play. The picture is compressed to show it in its entirety, but this may cause it to be stretched vertically.

## To clean discs

### DVD-Audio, DVD-Video, Video CD, CD

Wipe with a damp cloth and then wipe dry.

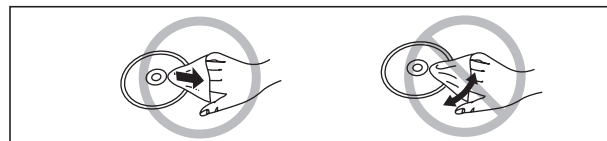

### DVD-RAM, DVD-R

- Clean with an optional DVD-RAM/PD disc cleaner (LF-K200DCA1, where available).
- Never use cloths or cleaners for CDs etc.

## Handling precautions

- Do not write on the label side with a ball-point pen or other writing instrument.
- Do not use record cleaning sprays, benzene, thinner, static electricity prevention liquids or any other solvent.
- Do not attach labels or stickers to discs. (Do not use discs with exposed adhesive from tape or left over peeled-off stickers.)
- Do not use scratch-proof protectors or covers.
- Do not use discs printed with label printers available on the market.

# Simple setup

## STEP 1 Locating

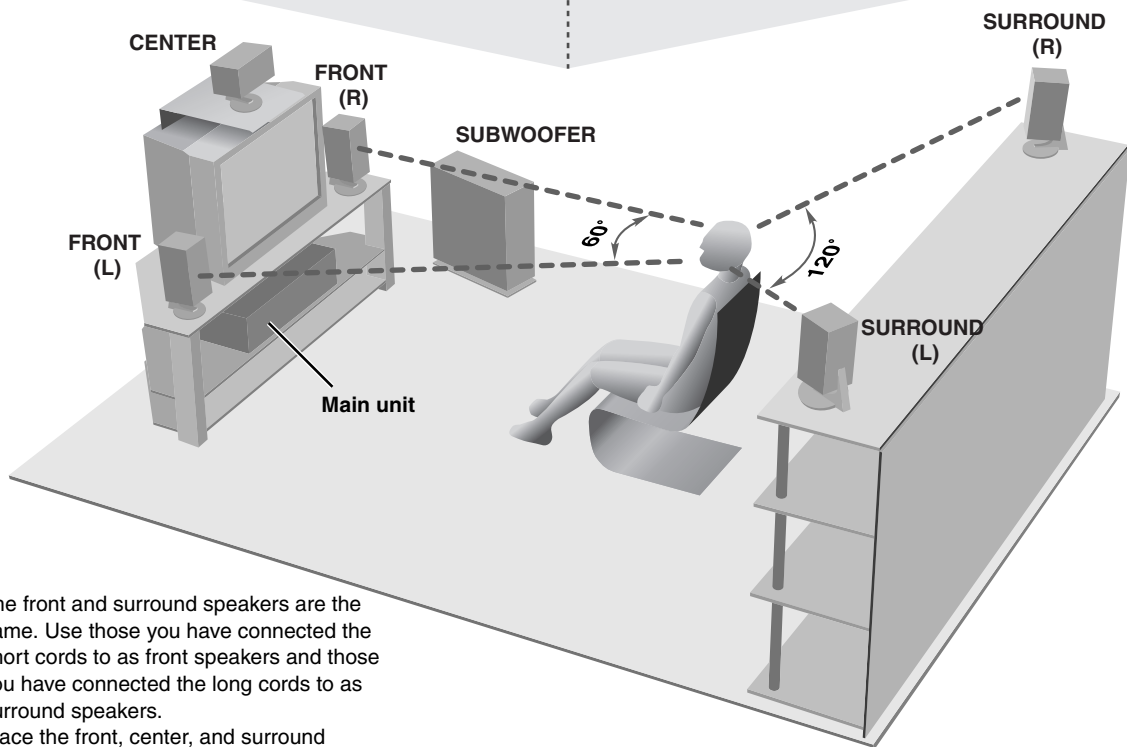
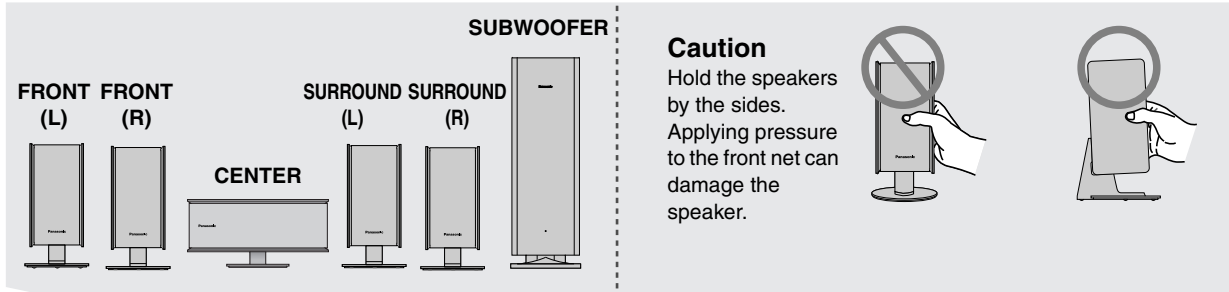

- The front and surround speakers are the same. Use those you have connected the short cords to as front speakers and those you have connected the long cords to as surround speakers.
- Place the front, center, and surround speakers at approximately the same distance from the seating position. The angles in the diagram are approximate.

### • Use only supplied speakers

Using other speakers can damage the unit and sound quality will be negatively affected.

- Set the speakers up on an even surface to prevent them from falling. Take proper precautions to prevent the speakers from falling if you cannot set them up on an even surface.

### Positioning for best effect

How you set up your speakers can affect the bass and the sound field. Note the following points.

- Place speakers on flat secure bases.
- Placing speakers too close to floors, walls, and corners can result in excessive bass. Cover walls and windows with thick curtain.

### Main unit

#### Note

Keep your speakers at least 10 mm ( $13/32$ " ) away from the system for proper ventilation.

### Center speaker

- You can also put this speaker directly under the television.
- Vibration caused by the center speaker can disrupt the picture if it is placed directly on the television. Put the center speaker on a rack or shelf.

### Subwoofer

Place to the right of the television, on the floor or a sturdy shelf so that it won't cause vibration.

Leave 10 cm (4" ) on the right for the woofer to be effective. Leave 10 cm (4" ) at the rear for ventilation.

# STEP 2 Speakers

## Speaker cables

- 3×4-m (13-foot) cables
- 2×10-m (33-foot) cables

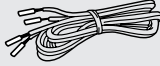

## Sheet of speaker-cable stickers



### Setup example

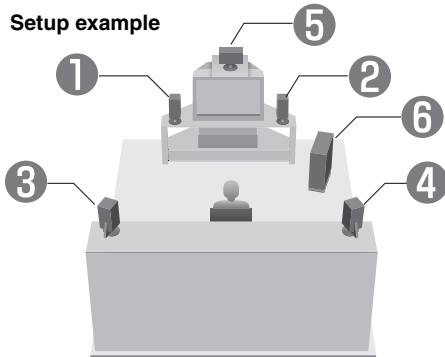

## 1 Attaching the stickers to the speaker cables

Attach the speaker-cable stickers to make connection easier.

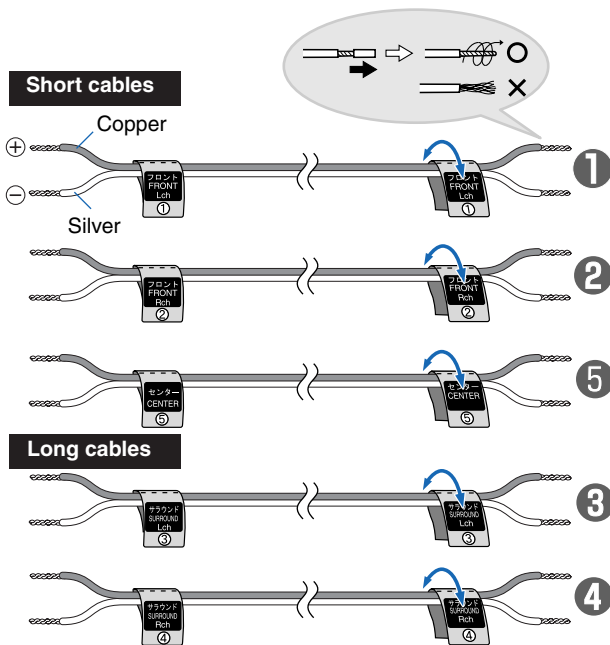

## 2 Connecting the speakers

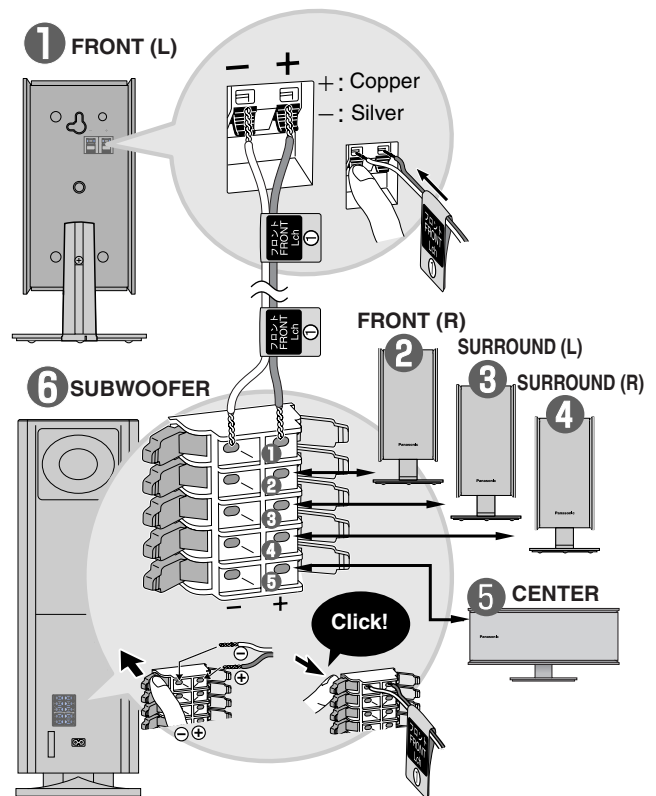

### Keeping the cables out of the way

Pass the cables through the holes in the stand to keep them out of the way.

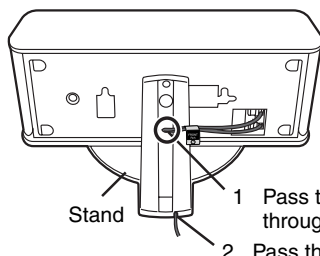

- 1 Pass the cable through the hole.
- 2 Pass through the cutout in the base.

### Note

- Never short-circuit positive (+) and negative (-) speaker wires.
- Be sure to connect only positive (copper) wires to positive (+) terminals and negative (silver) wires to negative (-) terminals. Incorrect connection can damage the speakers.

# STEP 3 Television

Video cable



## ■ Connecting a television with a VIDEO IN terminal

Television  
(not included)

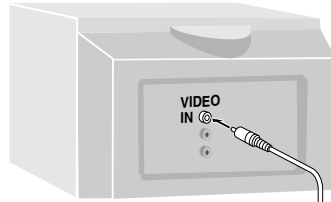

Video cable  
(included)

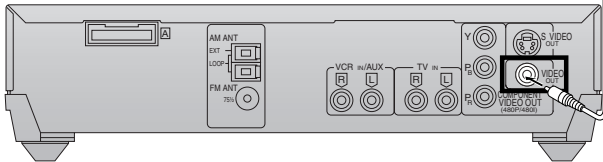

**Connect directly to your television.**

Do not connect the unit through a video cassette recorder, because the picture may not be played correctly due to the copy guard.

## ■ Connecting a television with COMPONENT VIDEO terminals

COMPONENT  
VIDEO IN

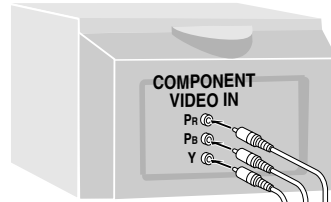

Video cables  
(not included)

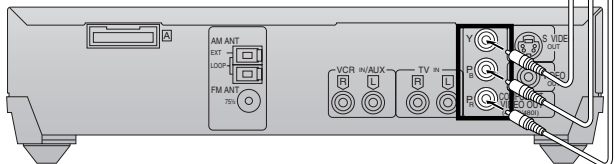

### COMPONENT VIDEO OUT terminal

These terminals can be used for either interlace or progressive output and provide a purer picture than the S VIDEO OUT terminal. Connection using these terminals outputs the color difference signals (P<sub>B</sub>/P<sub>R</sub>) and luminance signal (Y) separately in order to achieve high fidelity in reproducing colors.

- The description of the component video input terminals depends on the television or monitor (e.g. Y/P<sub>B</sub>/P<sub>R</sub>, Y/B-Y/R-Y, Y/C<sub>B</sub>/C<sub>R</sub>). Connect to terminals of the same color.
- After making this connection, change the black level for a better picture (➡ page 29, Video—Black Level Control).

### To enjoy progressive video

- Connect to the component video (480P) input terminals on a television compatible with this unit's copy guard system. (Video will not be displayed correctly if connected to an incompatible television.)
- Press [PROGRESSIVE OUT] on the main unit so "PROG." appears on the display (➡ page 13).
- All televisions manufactured by Panasonic and that have 480P input connectors are compatible. Consult the manufacturer if you have another brand of television.

## ■ Connecting a television with an S-VIDEO IN terminal

S VIDEO  
IN

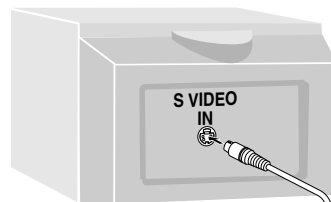

S-video cable  
(not included)

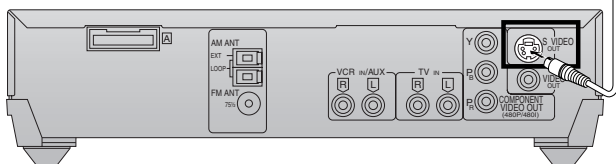

### S VIDEO OUT terminal

The S video terminal achieves a more vivid picture than the VIDEO OUT terminal by separating the chrominance (C) and luminance (Y) signals. (Actual results depend on the television.)



# STEP 4 Connecting the subwoofer, antennas, and AC power supply cord

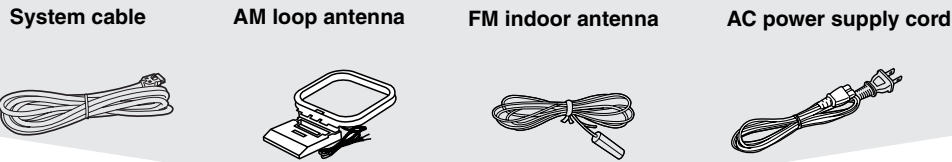

Connect the AC power supply cord after all other connections are complete.

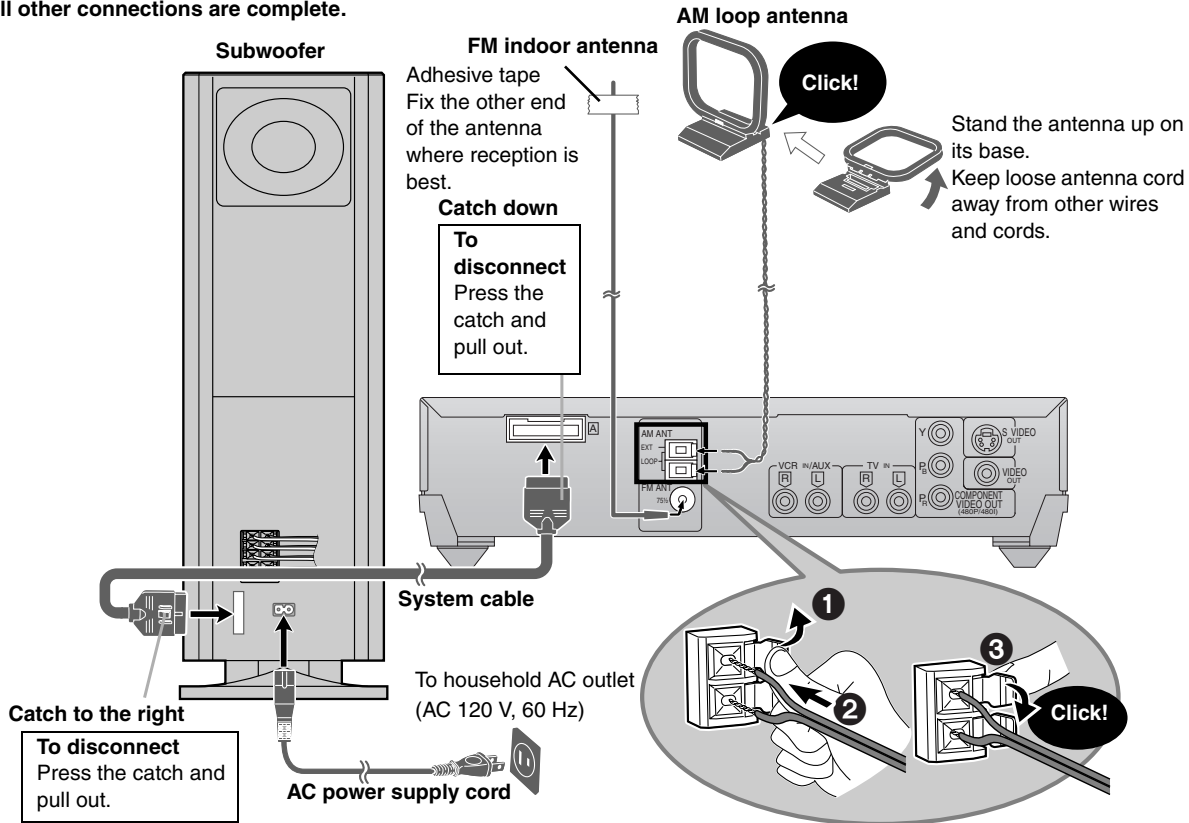

**Conserving power**  
The unit consumes power (approx. 0.5 W) even when it is turned off with [⏻]. To save power when the unit is not to be used for a long time, unplug it from the household AC outlet.

Remember to reset the radio stations and any other memory items before using the unit again.

Information you enter into the unit's memory remains intact for up to 2 weeks after the AC power supply cord is disconnected.

# STEP 5 The remote control

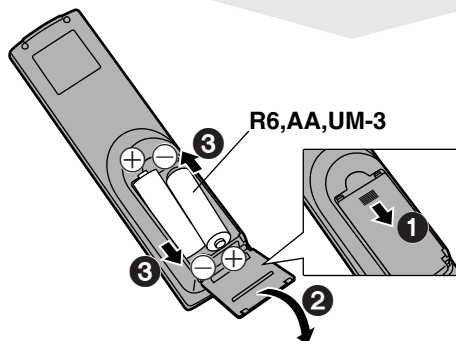

- Insert so the poles (+ and -) match those in the remote control.
- Do not use rechargeable type batteries.

**Do not;**

- mix old and new batteries.
- use different types at the same time.
- heat or expose to flame.
- take apart or short circuit.
- attempt to recharge alkaline or manganese batteries.
- use batteries if the covering has been peeled off.

Mishandling of batteries can cause electrolyte leakage which can damage items the fluid contacts and may cause a fire.

Remove if the remote control is not going to be used for a long period of time. Store in a cool, dark place.

**■ Use**

Aim at the sensor, avoiding obstacles, at a maximum range of 7 m (23 feet) directly in front of the unit.

# Other speaker setup options

## Attaching to a wall

### Note

The wall or pillar on which the speakers are to be attached should be capable of supporting 10 kg (22 lb.) per screw.

### 1 Remove the stand.

#### BEFORE REMOVING THE STAND

- Take the speaker cable out of the stand's hole if it is threaded through.
- Lay the speaker on a soft cloth.

Unscrew the screw with a Phillips-head screwdriver.

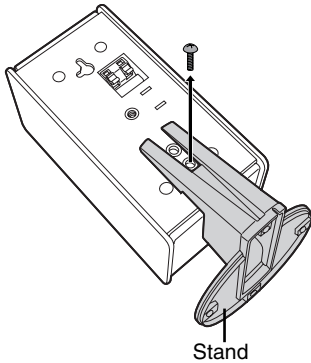

### 2 Screw a screw (not included) into the wall.

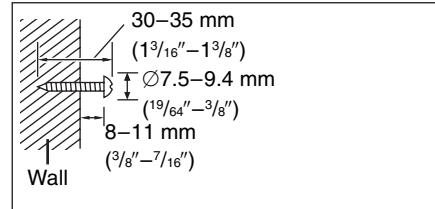

### 3 Fit the speaker securely onto the screw with the hole or holes.

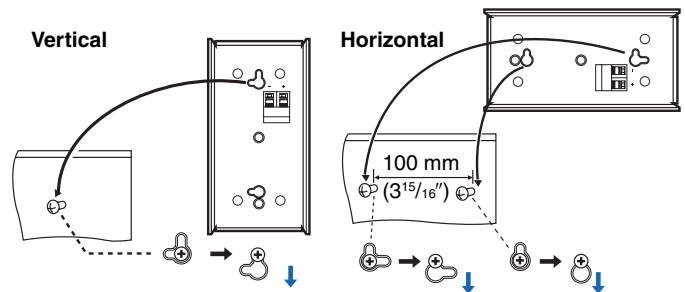

## Fitting speaker stands (optional)

### Preparation

Remove the stand (→ step 1 above).

Ensure the stands meet these conditions before purchasing them.

- Observe the diameter and length of the screws and the distance between screws as shown in the diagram.
- The stands must be able to support over 10 kg (22 lb.).
- The stands must be stable even if the speakers are in a high position.

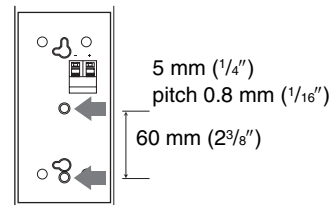

### Notes on speaker use

- You can damage your speakers and shorten their useful life if you play sound at high levels over extended periods.
- Reduce the volume in the following cases to avoid damage.
  - When playing distorted sound.
  - When the speakers are receiving howling from a record player, noise from FM broadcasts, or continuous signals from an oscillator, test disc, or electronic instrument.
  - When adjusting the sound quality.
  - When turning the unit on or off.

### If irregular coloring occurs on your television

These speakers are designed to be used close to a television, but the picture may be affected with some televisions and setup combinations.

### If this occurs, turn the television off for about 30 minutes.

The television's demagnetizing function should correct the problem. If it persists, move the speakers further away from the television.

	<p><b>Caution</b></p> <ul style="list-style-type: none"> <li>• Use the speakers only with the recommended system. Failure to do so may lead to damage to the amplifier and/or the speakers, and may result in the risk of fire. Consult a qualified service person if damage has occurred or if you experience a sudden change in performance.</li> <li>• Do not attempt to attach these speakers to walls using methods other than those described in this manual.</li> </ul>
--	--

# STEP 6 QUICK SETUP

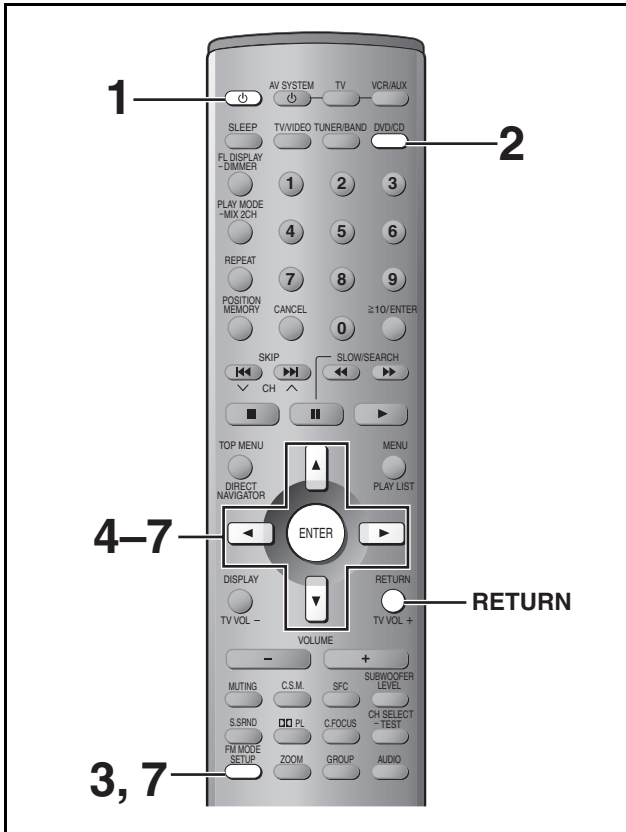

The **QUICK SETUP** screen appears when you press [SETUP] the first time after purchase and assists you to make necessary settings. You can access this screen again later if you need to (➔ page 29, Others—QUICK SETUP).

## Preparation

Turn on the television and select the appropriate video input on the television to suit the connections for the unit.

- 1** Press [POWER] to turn on the unit.
- 2** Press [DVD/CD] to select “DVD/CD” as the source.
- 3** Press [SETUP] to show the **QUICK SETUP** screen.

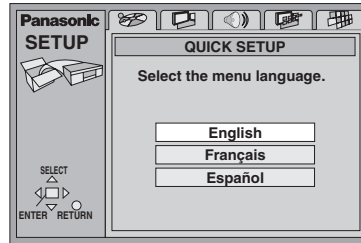

- 4** Press [▲, ▼] to select the menu language and press [ENTER].
- 5** Press [▲, ▼] to select “Yes” to continue and press [ENTER].
- 6** Press [▲, ▼, ◀, ▶] to select the item and press [ENTER].
  - Audio Language (➔ page 29)
  - Subtitle Language (➔ page 29)
  - TV Type (➔ below)
  - TV Aspect (➔ below)
- 7** Press [ENTER] and then [SETUP] to end the settings.

## To return to the previous screen

Press [RETURN].

## ■ TV Type

Select to suit the type of television.

- Standard (Direct View TV) (factory preset)
- CRT Projector
- LCD TV/Projector
- Projection TV
- Plasma TV

## ■ TV Aspect

Select “4:3” (regular) or “16:9” (widescreen) to suit your television.

If you have a regular 4:3 television, you can also select how video on some discs is shown (➔ page 29, Video—TV Aspect).

- **4:3 Pan&Scan** (factory preset)  
Widescreen software is expanded to fill the screen of a 4:3 aspect television (unless prohibited by the producer of the disc).
- **4:3 Letterbox**  
Widescreen software is shown in the letterbox style on a 4:3 aspect television.



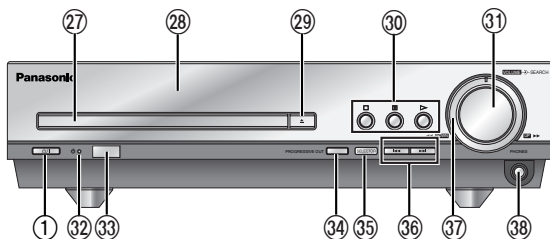
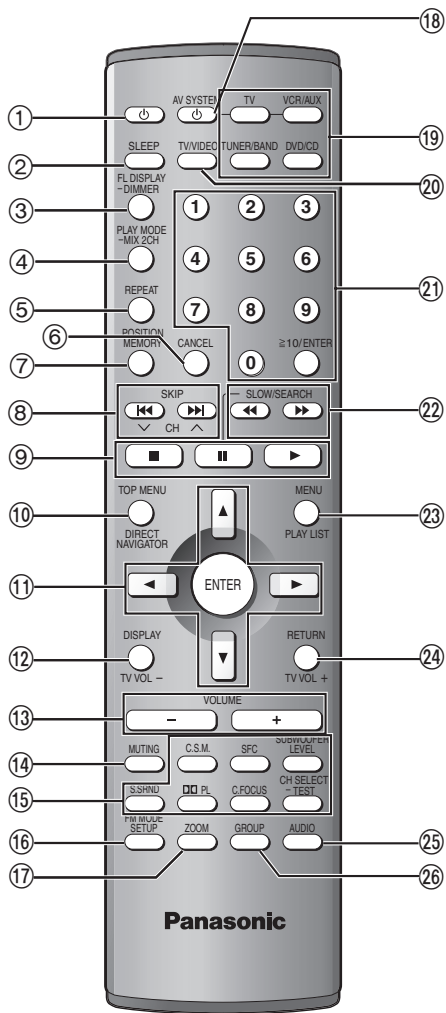

## Remote control

- ① Standby/on switch [⏻] .....11
- ② Sleep button [SLEEP] .....28
- ③ FL display, Dimmer button [FL DISPLAY, -DIMMER]...25, 28
- ④ Play mode, Mix 2ch button  
[PLAY MODE, -MIX 2CH] .....16, 25
- ⑤ Repeat button [REPEAT] .....15
- ⑥ Cancel button [CANCEL] .....16
- ⑦ Position memory button [POSITION MEMORY] .....13
- ⑧ Skip, Preset channel, TV channel buttons  
[◀◀ ▶▶, SKIP, √ CH ^] .....14, 24, 32
- ⑨ Basic operation buttons .....13
- ⑩ Top menu, Direct navigator button  
[TOP MENU, DIRECT NAVIGATOR] .....14, 20
- ⑪ Cursor buttons [▲, ▼, ◀, ▶], Enter button [ENTER] .....11
- ⑫ Display, TV volume down button  
[DISPLAY, TV VOL-] .....21, 32
- ⑬ Volume buttons [-, +, VOLUME] .....13
- ⑭ Muting button [MUTING] .....28
- ⑮ Sound field, sound quality buttons .....25-27
- ⑯ FM mode, Setup button [FM MODE, SETUP] .....11, 24
- ⑰ Zoom button [ZOOM] .....18
- ⑱ AV system standby/on button [⏻, AV SYSTEM] .....32
- ⑲ Source select buttons
  - Face towards this unit to change the source.
  - Press [TV] or [VCR/AUX] first to operate a Panasonic television or video cassette recorder (➡ page 32).
- ⑳ TV/VIDEO button [TV/VIDEO] .....32
- ㉑ Numbered buttons [1-9, 0, ≥10/ENTER] .....14
- ㉒ Slow/search, Tuning buttons  
[◀◀, ▶▶ SLOW/SEARCH] .....14, 24
- ㉓ Menu, Play list button [MENU, PLAY LIST] .....14, 20
- ㉔ Return, TV volume up button [RETURN, TV VOL+] .....11, 32
- ㉕ Audio button [AUDIO] .....17
- ㉖ Group button [GROUP] .....15

## Main unit

- ① Standby/on switch [⏻/I, POWER] .....11  
Press to switch the unit from on to standby mode or vice versa.  
In standby mode, the unit is still consuming a small amount of power.
- ⑲ Disc tray .....13
- ⑳ Display
- ㉑ Open/close button [▲] .....13
- ㉒ Basic operation buttons .....13
- ㉓ Volume control [VOLUME, DOWN, UP] .....13
- ㉔ Standby/on indicator [⏻]  
When the unit is connected to the AC mains supply, this indicator lights up in standby mode and goes out when the unit is turned on.
- ㉕ Remote control signal sensor
- ㉖ Progressive out button [PROGRESSIVE OUT] .....13
- ㉗ Source select button [SELECTOR]  
DVD/CD → FM → AM → TV → VCR/AUX
- ㉘ Skip, Preset channel buttons [◀◀ ▶▶] .....14, 24
- ㉙ Shuttle dial [SEARCH ◀◀, ▶▶] .....14
- ㉚ Headphone jack [PHONES] .....28

## Subwoofer

- ㉛ AC supply indicator [AC IN]  
This indicator lights when the unit is connected to the AC mains supply.

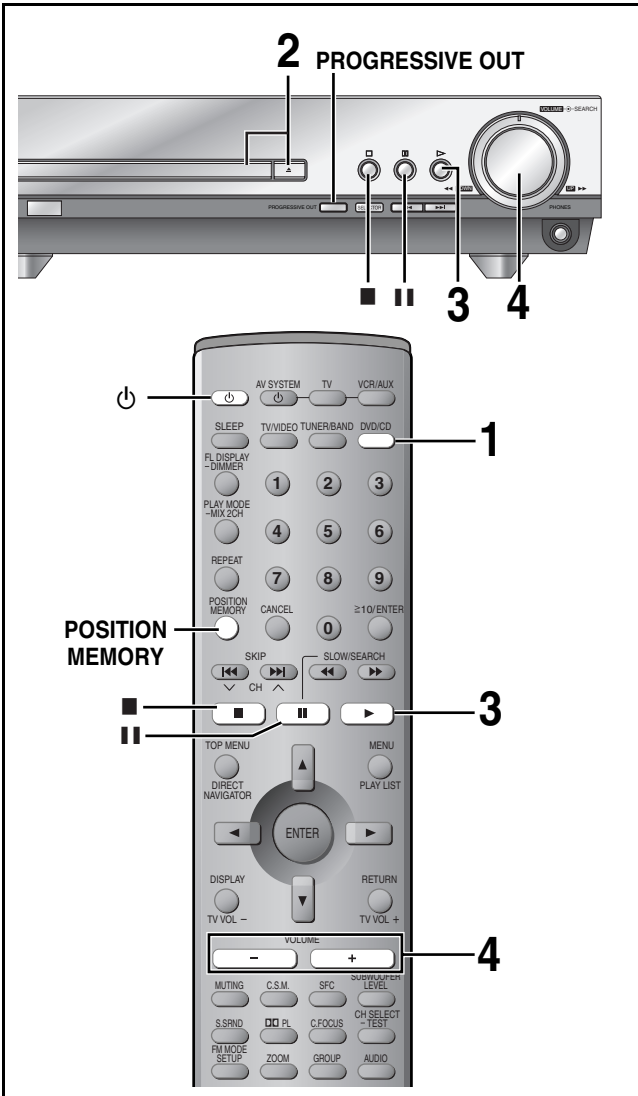

RAM DVD-A DVD-V VCD CD WMA MP3

## Preparation

- Press [⏻] to turn on the unit.
- Turn on the television and select the appropriate video input on the television to suit the connections for the unit.

## 1 Press [DVD/CD] to select “DVD/CD” as the source.

### To enjoy progressive video

#### Press [PROGRESSIVE OUT].

The television will be disrupted for a moment but this is normal.

- Output from this unit is interlace if you have connected to the television through VIDEO OUT or S-VIDEO OUT or playing PAL discs, even if “PROG.” is on the display.
- When progressive output is on, closed captions will not be displayed.



## 2 Press [▲] to open the disc tray and place the disc.

- Remove TYPE 2 and 4 discs from their cartridges before use. RAM

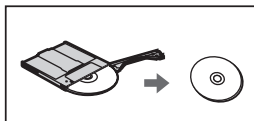

- Label-up (With double-sided discs, load so the label for the side you want to play is facing up.)

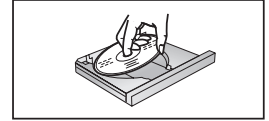

## 3 Press [▶] (play).

The disc tray closes and play begins.

WMA MP3 CD (CD text only)

Group and track names are displayed on the television.

- To turn the display on or off → page 22, Disc information ⑤
- You can also use the navigation menus to control play (→ page 19).

## 4 Adjust the volume.

Turn the inner dial on the main unit.

-- dB ◀▶ 0 dB

(Minimum) (Maximum)

### To pause play

Press [⏸] during play.

Press [▶] (play) to restart play.

### To stop play

Press [■] (→ below, Resume function).

#### Note

- If “⊙” appears on the television

The operation is prohibited by the unit or disc.

- It may take some time for play to start but this is normal.

## Position Memory function

RAM DVD-A DVD-V VCD CD WMA MP3

During play

## Press [POSITION MEMORY] to memorize a position.

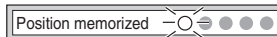

Press again to replace the position.

This position is saved even if you turn the unit off, change the source or open the disc tray. When you turn the unit on, reselect “DVD/CD” or reinsert the disc whose position you memorized, “RESUME” lights on the display. Press [▶] (play) to start play from the memorized position. The position is cleared.

- You can memorize positions on up to five different discs at a time.

When you memorize another position, the earliest position is replaced.

### Resume function

“RESUME” lights on the display when the unit has recorded the position at which you stopped play.

Press [▶] (play) to start play from that position.

- The position is cleared when you:
  - Turn the unit off.
  - Select another source or open the disc tray.
- Press [■] to clear the position.

### Chapter Preview

#### DVD-V

The following message appears immediately after you press [▶] (play) when “RESUME” is displayed. Press [▶] (play) while the message is displayed and the beginning portions of each chapter up to the current one are played.

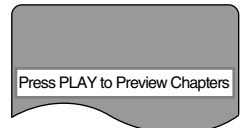

Full play resumes from the point where you pressed [■] or [POSITION MEMORY].

(This feature works only within a title.)

If you do not press [▶] (play), the message disappears and play starts from where you pressed [■] or [POSITION MEMORY].

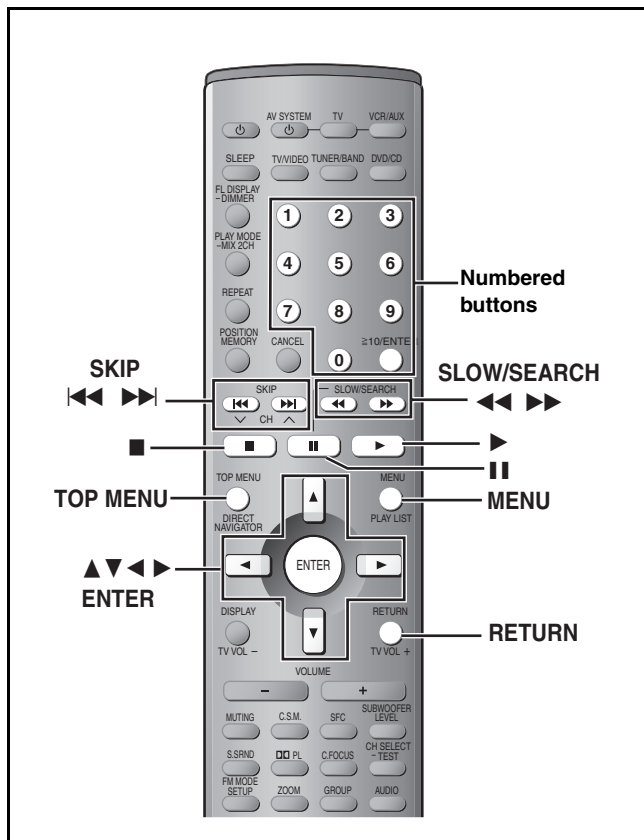

### When a menu appears on the television

**DVD-A DVD-V VCD**

### Press the numbered buttons to select an item.

#### To select a 2-digit number

Example: To select item 23, press  $\geq 10$  → [2] → [3].

- When playing DVDs, you can also use [▲, ▼, ◀, ▶] to select items. Press [ENTER] to confirm your selection.

#### To return to the menu screen

**DVD-A DVD-V** [TOP MENU]: Shows the first menu screen.

**DVD-V** [MENU]: Shows the menu screen.

**VCD** [RETURN]: Shows the menu screen.

#### Note

- The disc continues to rotate while the menu is displayed even after you finish playing an item. Press [■] when you finish to preserve the unit's motor and your television screen.

## Skipping items

**RAM DVD-A DVD-V VCD CD WMA MP3**

During play or while paused

Press [ $\lll$ ] or [ $\ggg$ ].

- Each press increases the number of skips.

**DVD-A DVD-V VCD CD WMA MP3**

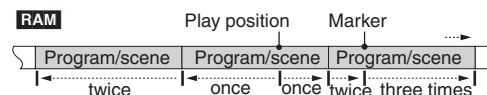
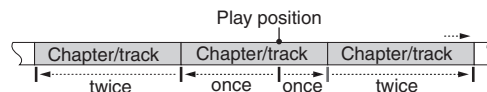

## Fast forward and rewind—SEARCH

**RAM DVD-A DVD-V VCD CD WMA MP3**

During play

Press [ $\lll$ ] or [ $\ggg$ ].

- Turn the shuttle dial [ $\lll$ ,  $\ggg$ ] (the outer dial) on the main unit. Play starts again when you release the shuttle dial.
- Audio will be heard during search for most discs. You can turn this audio off if you want to (⇒ page 29, Audio—Audio during Search).
- **DVD-V** You can slow down or speed up play (⇒ page 21).

## Slow-motion play

**RAM DVD-V VCD**

**DVD-A** (Motion picture parts only)

While paused

Press [ $\lll$ ] or [ $\ggg$ ].

Turn the shuttle dial [ $\lll$ ,  $\ggg$ ] (the outer dial) on the main unit. The picture stills again when you release the shuttle dial.

## Frame-by-frame viewing

**RAM DVD-V VCD**

**DVD-A** (Motion picture parts only)

While paused

Press [ $\ll$ ] or [ $\gg$ ].

The frame changes each time you press the button.

- The frames change in succession if you press and hold the button.
- Pressing [■] also activates forward frame-by-frame.

#### Notes

- The speed of search and slow-motion increases up to 5 steps.
- Press [▶] (play) to restart play.
- You cannot move backwards with Video CD during frame-by-frame and slow-motion.

#### When playing Video CDs with playback control

Pressing buttons to perform skip, search or slow-motion may take you to a menu screen.

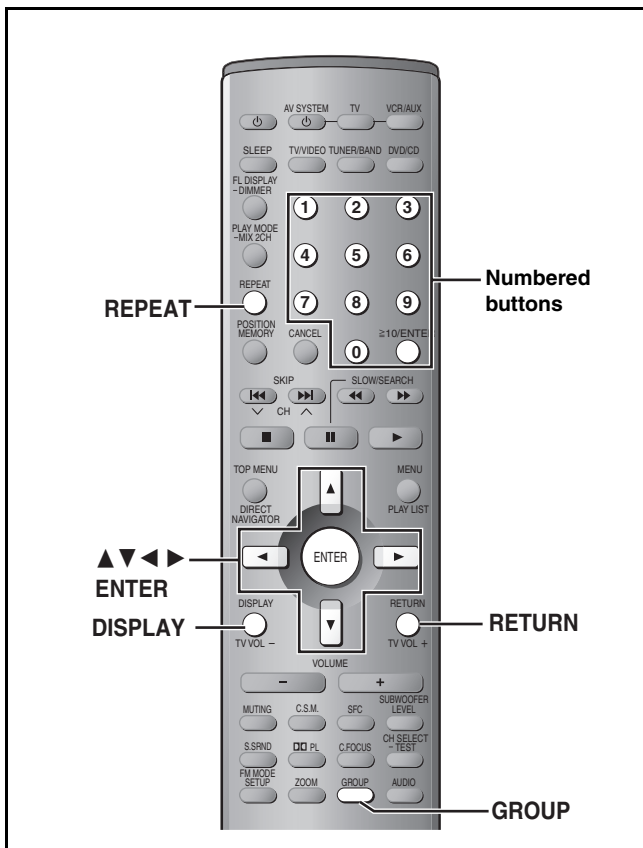

## Starting play from a selected item

**RAM DVD-A DVD-V VCD CD WMA MP3**  
**Press the numbered buttons to select the item.**

Play starts from the selected item.

**To select a 2-digit number**

Example: To select track 23, press [ $\geq 10$ ]  $\rightarrow$  [2]  $\rightarrow$  [3].

**WMA MP3** [2]  $\rightarrow$  [3]  $\rightarrow$  [ENTER]

### Note

This works only when stopped with some discs.

## Repeat play

**RAM DVD-A DVD-V VCD CD WMA MP3**

During play

**Press [REPEAT].**

Each time you press the button:

### RAM

Program  $\rightarrow$  All (Entire disc)  $\rightarrow$  Off

• During play list play

Scene  $\rightarrow$  Playlist  $\rightarrow$  Off

### DVD-V

Chapter  $\rightarrow$  Title\*  $\rightarrow$  Off

### VCD CD

Track  $\rightarrow$  All (Entire disc)  $\rightarrow$  Off

### DVD-A WMA MP3

Track  $\rightarrow$  Group\*  $\rightarrow$  Off

※ During all group (DVD-A), program and random play

“All” is displayed.

### ■ To repeat only your favorite tracks/chapters

Start program play ( $\rightarrow$  page 16) and press [REPEAT] to select the repeat mode.

## A-B repeat play

**RAM DVD-A DVD-V VCD CD WMA MP3**

You can repeat a section between points A and B within a program, title or track.

**1** During play

**Press [DISPLAY] until the unit information screen is displayed**

( $\rightarrow$  page 22).

**2** Press [ $\blacktriangle$ ,  $\blacktriangledown$ ] to select the play menu.



A-B Repeat

**3** Press [ $\blacktriangleleft$ ,  $\blacktriangleright$ ] to select “A-B Repeat” and

① Press [ENTER] at the starting point (A).

② Press [ENTER] at the finishing point (B).



A-B repeat starts.

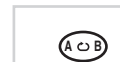

**To return to the normal play**

Press [ENTER] again.

**To clear the menus**

Press [RETURN] until the menu disappears.

## Selecting groups to play

**DVD-A WMA MP3**

**1** During play

**Press [GROUP].**

Example **MP3**



Track number in group  
Group number

**2** Press the numbered buttons to select the group and press [ENTER].

**3** Press the numbered buttons to select the track number and press [ENTER].

### DVD-A

Playing all the groups in succession ( $\rightarrow$  page 16, All group play)

### Playing bonus groups

Some discs contain bonus groups. If a password screen appears after selecting a group, enter the password with the numbered buttons. Refer also to the disc's jacket.

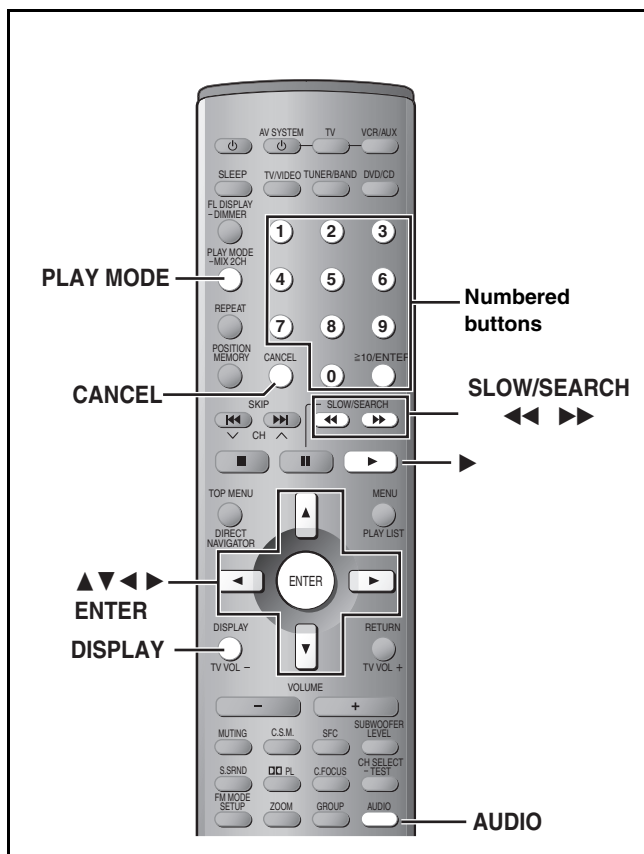

DVD-A DVD-V VCD CD WMA MP3

## Common procedures for all group, program and random play

### While stopped

Press [PLAY MODE].

Each time you press the button:

All group (DVD-A) → Program → Random  
 ↑ Off (Normal play) ↓

### DVD-A

If you select bonus groups, you will have to enter a password (→ page 15).

## All group play

DVD-A

Press [▶] (play).

ALL

## Program play

You can select up to 32 items to play in the order you choose.

Example DVD-V

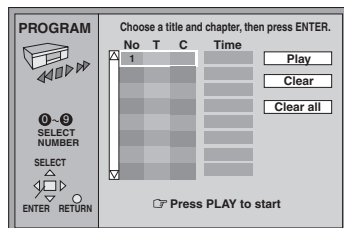

1 Press the numbered buttons to select a title, chapter, group or track (WMA MP3 then press [ENTER]).

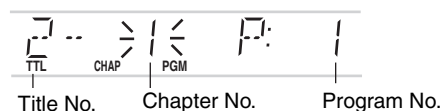

### To select a 2-digit number

Example: To select item 25, press [≥10] → [2] → [5].

WMA MP3: [2] → [5] → [ENTER]

### Repeat this step to program other items.

### To select an item using the cursor buttons

Press [ENTER] and [▲, ▼] to select an item, then press [ENTER] again to register the number.

All the items in the selected disc, title or group are selected when you select "ALL".

2 Press [▶] (play).

### To add or change the program

Press [▲, ▼] to select an available item, then repeat step 1.

### To move to the page before or after the one shown

Press [◀, ▶].

### To clear an item

1 Select the item you want to clear with [▲, ▼].

2 Press [CANCEL], or select "Clear" with [▲, ▼, ◀, ▶] and press [ENTER].

### To clear the whole program

Select "Clear all" with [▲, ▼, ◀, ▶] and press [ENTER].

### Note

#### DVD-V WMA MP3

Times are not displayed while programming.

The program is cleared when you switch the unit to standby, open the disc tray, select another source, or exit the program mode by pressing [PLAY MODE].

## Random play

1 DVD-A DVD-V

Press the numbered buttons to select a title or a group.

Example DVD-V



DVD-A

You can select more than one group.

To enter all groups, select "All" using [◀, ▶] and press [ENTER].

To deselect a group, press the numbered buttons corresponding to the group you want to clear.

2 Press [▶] (play).



- “\_” or “—” is displayed instead of the language number in circumstances such as when no language is recorded on the disc.

## Soundtracks

RAM DVD-A DVD-V VCD

(Discs with multiple soundtracks)

During play

### Press [AUDIO].

The number changes each time you press the button.

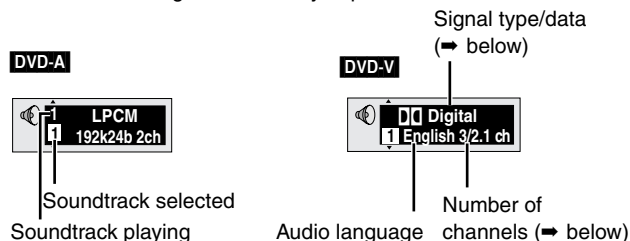

RAM VCD

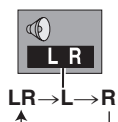

- You can also use this button to turn the vocals on and off on karaoke discs. Read the disc's instructions for details.

DVD-A

- Play restarts from the beginning of the soundtrack when changing soundtracks that are accompanied by still pictures.
- Even if a second soundtrack isn't recorded, two soundtrack numbers will normally be shown when you press [AUDIO]. The soundtrack currently playing is number 1.

### Signal type/data

LPCM/PPCM/Digital/DTS: Signal type

k (kHz): Sampling frequency

b (bit): Number of bits ch (channel): Number of channels

Example:

3/2 .1ch

.1: Low frequency effect  
(not displayed if there is no signal)

0: No surround  
1: Mono surround  
2: Stereo surround (left/right)

1: Center  
2: Front left+Front right  
3: Front left+Front right+Center

## Subtitles

DVD-A (Motion picture parts only)

DVD-V

(Discs with multiple subtitle languages)

You can change the subtitle language and turn the subtitles on and off.

RAM

You can turn the subtitles on and off.

### 1 During play

Press [DISPLAY] until the disc information screen is displayed.



### 2 Press [◀, ▶] to select “Subtitle Number”.



### 3 Press [▲, ▼] to select the language.

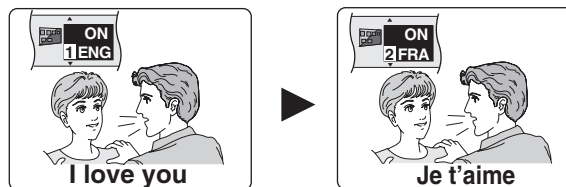

- In some cases, the subtitle language is not changed to the selected one immediately.
- Refer to “Audio/Subtitle language” (⇒ page 22) for language abbreviations.
- If the subtitles overlap closed captions recorded on discs, turn the subtitles off.

### To clear/display the subtitles

1 Press [◀, ▶] to highlight the following icon.

DVD-A DVD-V RAM



2 Press [▲, ▼] to select “OFF” or “ON”.

### ■ Changing the position and brightness of the subtitles (⇒ page 23)

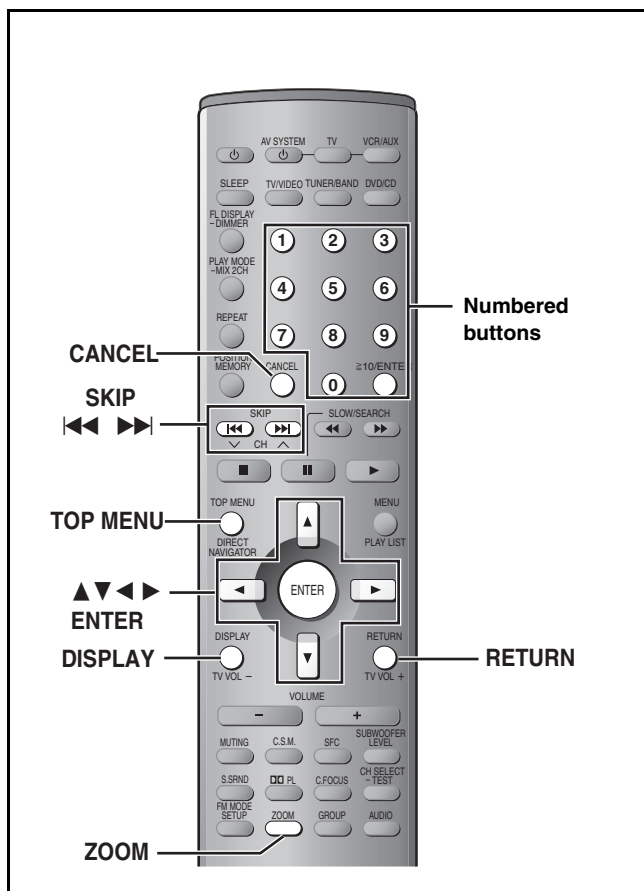

## Marking places to play again

**RAM** DVD-A DVD-V VCD CD WMA MP3

You can mark a position so you can return to it easily at a later time.

- 1** During play  
**Press [DISPLAY] until the unit information screen is displayed**  
 (⇒ page 22).
- 2** Press [▲, ▼] to select the play menu.  
 Example **DVD-V** 
- 3** Press [◀, ▶] to select “Marker” and press [ENTER].  
**RAM**  
 Press [▶] to select an asterisk (\*).
- 4** Press [ENTER] at the point you want to mark.

### To mark another position

Up to 5 points (**RAM** only: up to 999 points)

- Press [▶] to select “\*”.
- Press [ENTER] at the point.

### To recall or erase a marker

- Press [◀, ▶] to select a marker.
- Press [ENTER] to recall or press [CANCEL] to erase.

## RAM

### To mark the eleventh point and beyond

- Press [◀, ▶] to select the marker pin icon.

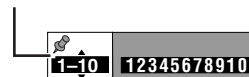

- Press [▲, ▼] to select “11–20”.

You can select the next group when the current group is full.

## Note

Markers added with this unit clear when you switch the unit to standby, change the source, or open the disc tray.

## Variable Zoom function

**RAM** DVD-V VCD

**DVD-A** (Motion picture parts only)

Change the zoom ratio so the picture expands to the optimum size to fill the screen.

### Preparation

Change the setting “TV Aspect” to suit your television (⇒ page 29).

### During play

**Press [ZOOM] to select the aspect ratio.**

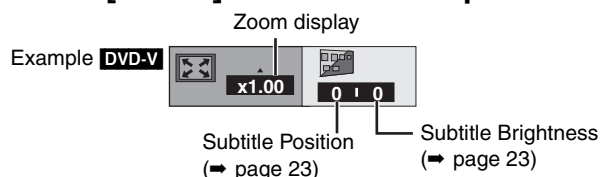

Each time you press the button:

**4:3 Standard → European Vista → 16:9 Standard**

**Cinemascope2 ← Cinemascope1 ← American Vista**

• Refer to the disc’s instructions and “Screen size” below for the aspect ratio of the picture.

### To restore the original ratio

Press [ZOOM] until the ratio returns to 1.00.

- The ratio also returns to 1.00 when you open the disc tray, change the source or switch the unit to standby.
- The ratio may return to 1.00 when a menu is displayed.

### Making fine adjustments to the zoom ratio

While the ZOOM icon is displayed

Press [▲, ▼].

The ratio changes in 0.01 units between 1.00 and 1.60 and in 0.02 units between 1.60 and 2.00.

## Screen size

Movies are made using a variety of screen sizes.

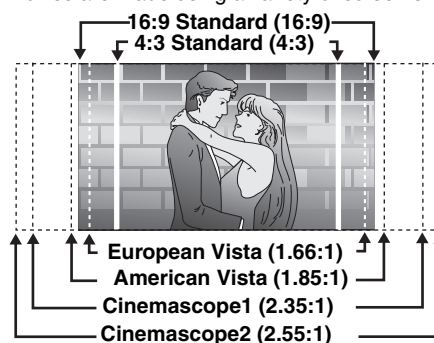

**WMA** **MP3** **CD** (CD text only)

Various menus help you find items you want to start play.

## 1 Press [TOP MENU].

Example **MP3** navigation menu

Group name

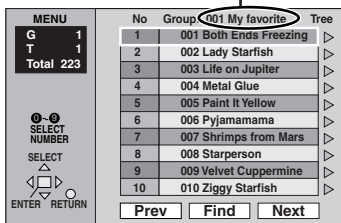

## 2 Press [▲, ▼] to select a track, and press [ENTER].

"" indicates the track currently playing.

### To show other pages

Press [▲, ▼, ◀, ▶] to select "Prev" or "Next" and press [ENTER]. After listing all the tracks in one group, the list for the next group appears.

### To exit the navigation menu

Press [TOP MENU].

### Track title search

Example: finding a track including the word "LOVE"

## 1 Press [▲, ▼] to select "Find" and press [ENTER].

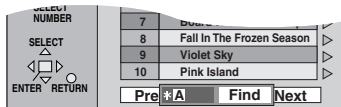

## 2 Press [▲, ▼] to select "L" and press [ENTER].

Characters change in alphanumeric order each time you press [▲].

Repeat this step to enter "O", "V", and "E".

- Press [◀, ▶] to skip between A, E, I, O, and U.
- Only uppercase appear but the search also includes lower case.
- Press [◀] to erase a character.
- You can erase the asterisk (\*) to search for the first word in a title.
- You can enter numbers with the numbered buttons.

## 3 Press [▶] to select "Find" and press [ENTER].

The search results screen appears.

## 4 Press [▲, ▼] to select the track and press [ENTER].

### To return to the navigation menu

Press [RETURN].

To use the tree screen to find a group **WMA** **MP3**

## 1 Press [▶] while a track is highlighted to display a tree screen.

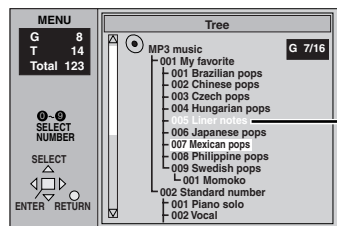

You cannot select groups that contain no compatible files.

## 2 Press [▲, ▼, ◀, ▶] to select a group and press [ENTER].

The navigation menu for the group appears.

### To return to the navigation menu

Press [RETURN].

To use the contents screen to find a track

**CD** (CD text only)

You can use the text information recorded on these discs to find a track to play.

## 1 Press [▶] while a track is highlighted to display the contents screen.

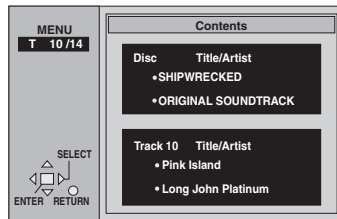

## 2 Press [◀, ▶] to move through the tracks and press [ENTER].

See page 34 for details about WMA, MP3, and CD text.

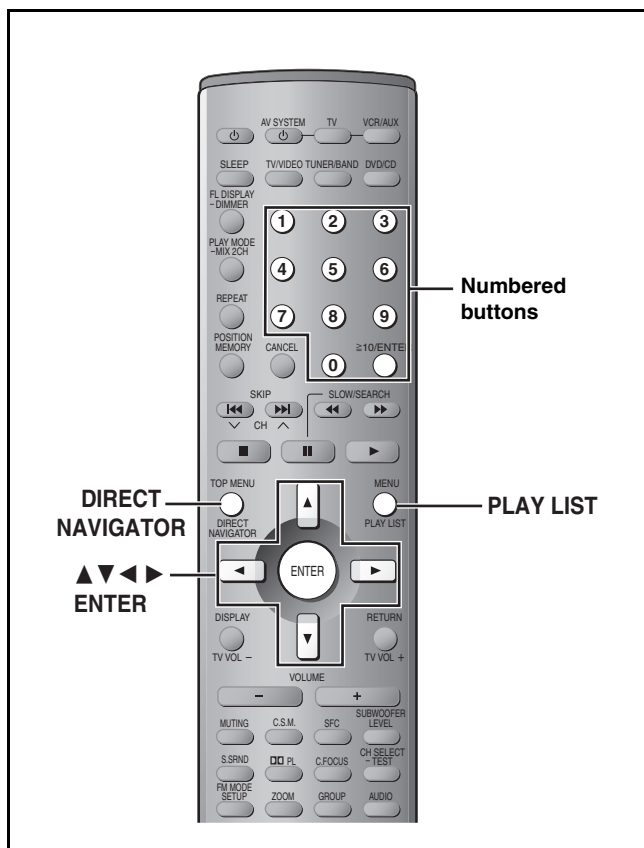

## Using the play list menu

You can play a group of scenes, a play list, created on other equipment such as a DVD video recorder.

### 1 Press [PLAY LIST].

PLAYLIST			
No	Date	Length	Title
1	10'17	0:46:35	
2	10'24	0:09:15	
3	11'29	0:12:32	
4	12'22	0:07:30	
5	12'25	0:10:30	
6	12'29	0:02:45	
7	12'29	0:09:15	
8	12'30	0:12:32	
9	12'30	0:07:30	
10	12'31	0:10:30	

### 2 Press [▲, ▼] to select the play list.

• You can select play lists with the numbered buttons.

**To select a 2-digit number**

Example 23: [ $\geq 10$ ] → [2] → [3]

### 3 Press [ENTER] to start play.

**To clear the play list screen**

Press [PLAY LIST].

## RAM

## Selecting a program to play —DIRECT NAVIGATOR

Use the program list to find programs to play.

### 1 Press [DIRECT NAVIGATOR].

DIRECT NAVIGATOR			
No	Date	On	Program Title
1	12'23(SAT)	21:02	Saturday feature
2	12'28(TUE)	14:35	Auto action
3	1'12(FRI)	20:00	Sunday Cinema
4	12'4(WED)	19:30	Music
5	2'20(TUE)	19:05	Baseball

### 2 Press [▲, ▼] to select the program.

The selected program plays in the background.

• You can select programs with the numbered buttons.

**To select a 2-digit number**

Example 23: [ $\geq 10$ ] → [2] → [3]

### 3 Press [ENTER].

The program being played in the background continues.

**To clear the program list**

Press [DIRECT NAVIGATOR].

## Note

- Titles appear only if you have entered them.
- You cannot change program and disc titles.

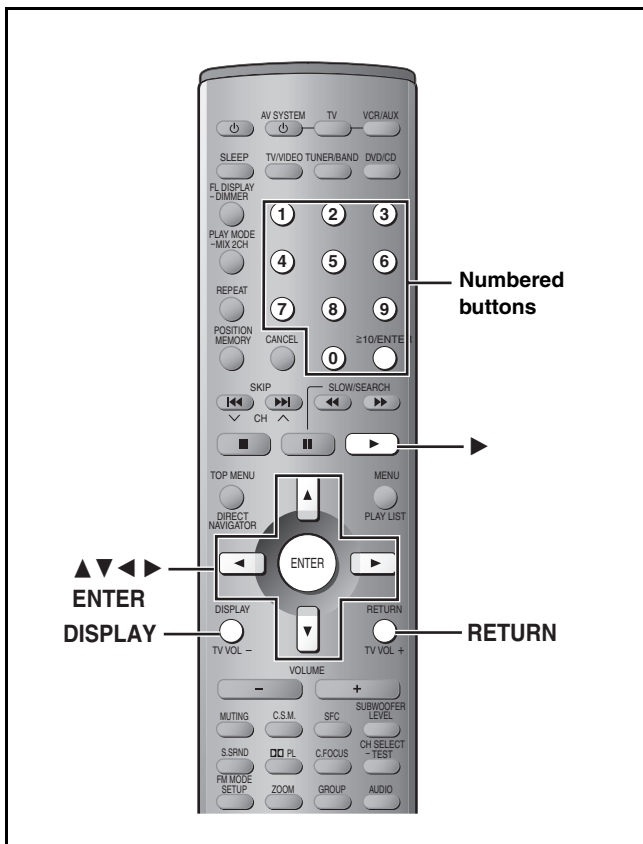

RAM DVD-A DVD-V VCD CD WMA MP3

On-Screen Menu Icons are menus that contain information about the disc or unit. These menus allow you to perform operations by changing this information.

## Common procedures

### 1 Press [DISPLAY].

Each time you press the button:

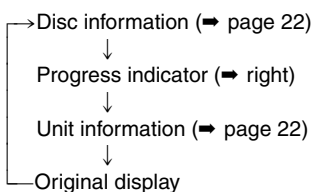

### 2 Unit information only

While the leftmost icon is highlighted Press [▲, ▼] to select the menu.

Each time you press the button:

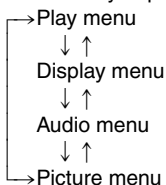

### 3 Press [◀, ▶] to select the item.

### 4 Press [▲, ▼] to select the setting.

- Items with “▲” or “▼” above and below can be changed by [▲, ▼].
- Press [ENTER] if the setting does not change after pressing [▲, ▼].
- Some items require different operations. Read the explanations on the following pages.

#### For your reference

- Depending on the condition of the unit (playing, stopped, etc.) and the type of software you are playing, there are some items that you cannot select or change.
- When numbers are displayed (e.g. title No.), the numbered buttons are also effective for setting. After entering the numbers, press [ENTER] to register the setting.

#### To clear the menus

Press [RETURN] until the menus disappear.

#### ■ To change the position of the icons

- 1 Press [◀, ▶] to select the rightmost icon.
- 2 Press [▲, ▼] to move the icons. (There are 5 positions.)



## Progress indicator

Indicates how far you have played through an item.  
Example **DVD-V**

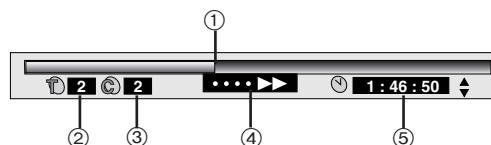

- ① **Current position** RAM DVD-A DVD-V VCD CD WMA MP3
- ② **PG: Program number** RAM  
**PL: Play list number** RAM  
**T: Title number** DVD-V  
**Track number** VCD CD  
**G: Group number** DVD-A WMA MP3
- ③ **T: Track number in group** DVD-A WMA MP3  
**C: Chapter number** DVD-V
- ④ **Condition – play, pause, or slow/search**  
RAM DVD-A DVD-V VCD CD WMA MP3  
Play speed (→ below)
- ⑤ **Changing the time display** RAM DVD-A DVD-V VCD CD  
Press [▲, ▼] to show the elapsed play time or remaining time for the program, play list, track or title (or chapter during program and random play).  
**Elapsed play time** WMA MP3  
(display only, cannot be changed)

### Changing play speed

**DVD-V** (Dolby Digital only)

You can slow down or speed up play.

**During play**

Press [◀] (slower) or [▶] (faster).

There are five speeds:

×0.8 ↔ ×0.9 ↔ ×1.0 (normal speed) ↔ ×1.2 ↔ ×1.4

After you change the speed, output is in stereo.

Sound is stereo as long as “×1.0” is orange.

To return to normal play (surround sound), press [▶] (play) or [ENTER].

Normal play is also restored when you return the speed to ×1.0 and clear the progress indicator.

Unless otherwise indicated, select items with [◀, ▶] and change with [▲, ▼].

## Disc information

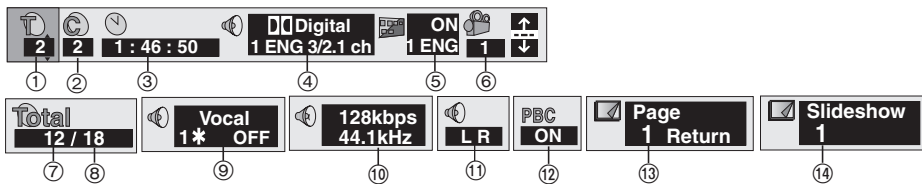

Disc operations

①	PG: Program number <b>RAM</b> PL: Play list number <b>RAM</b> G: Group number <b>DVD-A</b> <b>WMA</b> <b>MP3</b> T: Title number <b>DVD-V</b> Track number <b>VCD</b> <b>CD</b>	[▲, ▼] ↓ [ENTER]
②	T: Track number in group <b>DVD-A</b> <b>WMA</b> <b>MP3</b> C: Chapter number <b>DVD-V</b>	
③	<b>Time</b> <b>RAM</b> <b>DVD-A</b> <b>DVD-V</b> Select a position to start play by specifying a time.	Numbered buttons ↓ [ENTER]
	<b>Changing the time display</b> <b>RAM</b> <b>DVD-A</b> <b>DVD-V</b> <b>VCD</b> <b>CD</b> ( <b>WMA</b> <b>MP3</b> Display only) → Elapsed play time for the program, play list, or track ↓ ↑ Remaining time for the group ( <b>DVD-A</b> ) or disc ( <b>VCD</b> <b>CD</b> ) ↓ ↑ → Remaining time for the program, play list, title or track	
④	<b>Soundtrack</b> <b>RAM</b> <b>DVD-A</b> <b>DVD-V</b> (⇒ page 17)	
⑤	<b>Subtitle language</b> <b>DVD-A</b> <b>DVD-V</b> (⇒ page 17) <b>Subtitles on/off</b> <b>RAM</b> <b>DVD-A</b> <b>DVD-V</b> <b>Track information on/off</b> <b>WMA</b> <b>MP3</b> <b>CD</b> (CD text only)	
⑥	<b>Angle number</b> <b>DVD-A</b> <b>DVD-V</b>	

⑦	<b>Track number in disc</b> <b>WMA</b> <b>MP3</b>	[▲, ▼] ↓ [ENTER]
⑧	<b>Total number of tracks on disc</b> <b>WMA</b> <b>MP3</b>	Display only
⑨	<b>Karaoke vocal on/off</b> <b>DVD-V</b> (Karaoke DVD only) If a DVD title is a duet, select V1 or V2 to duet with the unit.	
⑩	<b>Current bitrate (kbps)</b> <b>Current sampling frequency (kHz)</b> <b>WMA</b> <b>MP3</b>	Display only
⑪	<b>Audio mode</b> <b>RAM</b> <b>VCD</b> LR ↔ L ↔ R ↑ ↔ ↓	
⑫	<b>Menu play</b> <b>VCD</b> (with playback control only)	Display only
⑬	<b>Still picture number</b> <b>DVD-A</b> • To return to page 1 [◀, ▶] → Select "Return" → [ENTER]	
⑭	<b>Slideshow</b> <b>DVD-A</b> Picture number	Display only

### Audio/Subtitle language

ENG: English FRA: French DEU: German ITA: Italian ESP: Spanish NLD: Dutch	SVE: Swedish NOR: Norwegian DAN: Danish POR: Portuguese RUS: Russian JPN: Japanese	CHI: Chinese KOR: Korean MAL: Malay VIE: Vietnamese THA: Thai *: Others
--	---	--

## Unit information

### Play menu

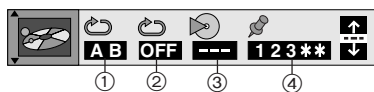

①	<b>A-B repeat</b> (⇒ page 15) <b>RAM</b> <b>DVD-A</b> <b>DVD-V</b> <b>VCD</b> <b>CD</b> <b>WMA</b> <b>MP3</b>	[ENTER]
②	<b>Repeat mode</b> (⇒ page 15) <b>RAM</b> <b>DVD-A</b> <b>DVD-V</b> <b>VCD</b> <b>CD</b> <b>WMA</b> <b>MP3</b>	
③	<b>Play mode</b> (⇒ page 16) <b>DVD-A</b> <b>DVD-V</b> <b>VCD</b> <b>CD</b> <b>WMA</b> <b>MP3</b> ---: Normal play PGM: Program play RND: Random play ALL: All group play ( <b>DVD-A</b> )	Display only
④	<b>Marker</b> <b>RAM</b> <b>DVD-A</b> <b>DVD-V</b> <b>VCD</b> <b>CD</b> <b>WMA</b> <b>MP3</b>	⇒ Page 18

### Audio menu

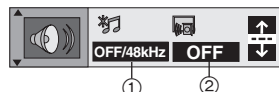

①	<b>Re-master</b> (⇒ page 27) <b>RAM</b> <b>DVD-A</b> <b>DVD-V</b> <b>CD</b> <b>WMA</b> <b>MP3</b>	
②	<b>Dialogue Enhancer on/off</b> <b>DVD-V</b> (Discs where the dialogue is recorded in the center channel) This makes the dialogue in movies easier to hear.	

## Display menu

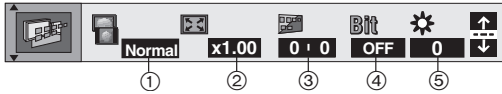

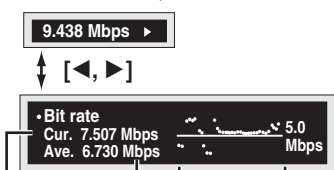
①	<b>4:3 Aspect</b> <b>RAM DVD-A DVD-V VCD</b> Select how to show images made for 4:3 aspect screens on a 16:9 aspect television. ● <b>Normal:</b> laterally stretches images made for a 4:3 screen. ● <b>Auto:</b> expands suitable 4:3 letterbox images to fill more of the screen. Other images appear in full in the center of the screen. ● <b>Shrink:</b> images appear in the center of the screen. ● <b>Zoom:</b> expands all images to fill the screen. If your television has a similar feature, use it instead for a better effect.
②	<b>Zoom (→ page 18)</b> <b>RAM DVD-A DVD-V VCD</b> [ENTER] ↓ [◀, ▶] ↓ [ENTER] <hr/> <b>Making fine adjustments to the zoom ratio</b>
③	<b>Subtitle position/Subtitle brightness DVD-A DVD-V</b> ● Position (0 to -60): in 2 unit steps ● Brightness (Auto*/0 to -9) *The brightness adjusts automatically against the background.
④	<b>Bitrate display on/off RAM DVD-A DVD-V VCD</b> During play: shows the bitrate (approximate values) of the video being played While paused: shows the data volume of the frame and type of picture (→ page 34, Glossary—I/P/B)  Current bitrate      A record of bitrates for a sampling period. Average bitrate
⑤	<b>OSD brightness (-3 to +3)</b> Adjust the brightness of the on-screen displays.

## Picture menu RAM DVD-A DVD-V VCD

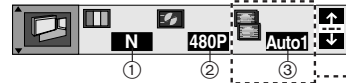

Only when "PROG." is on

①	<b>Picture mode</b> ● <b>N:</b> Normal mode ● <b>S:</b> Soft mode (Soft picture with fewer video artifacts) ● <b>F:</b> Fine mode (Details are sharper) ● <b>C1:</b> Mellows images and enhances detail in dark scenes ● <b>C2:</b> Sharpens images and enhances detail in dark scenes ● <b>U1/U2/U3:</b> User mode (→ below)
②	<b>Video output mode</b> ● <b>480I:</b> Interlace video ● <b>480P:</b> Progressive video ("PROG." is on)
③	<b>Transfer mode</b> Select the method of conversion for progressive output to suit the type of material being played. ● <b>Auto 1 (normal):</b> for viewing film material ● <b>Auto 2:</b> for viewing film material (the same as Auto 1, but able to convert 30-frame-per-second progressive video) ● <b>Video:</b> for video material

### To change the user mode

- Select User mode and press [▶] to highlight the number.
- Press [▲, ▼] to select "1", "2" or "3".



### U1: MPEG D.N.R. (Digital Noise Reduction)

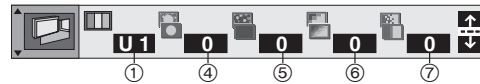

④	<b>Depth Enhancer (0 to +4)</b> Reduces the rough noise in the background to give a greater feeling of depth.
⑤	<b>3D-NR (0 to +4)/Dot NR (On)</b> Reduces overall noise/Reduces the dot noise that occurs at the borders between colors.
⑥	<b>Block NR (0 to +3)</b> Smoothes block noise.
⑦	<b>Mosquito NR (0 to +3)</b> Reduces the smudging that appears around contrasting sections of the picture.

### U2

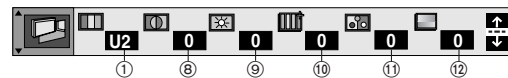

⑧	<b>Contrast (-7 to +7)</b> Increases the contrast between light and dark parts of the picture.
⑨	<b>Brightness (0 to +15)</b> Brightens the picture.
⑩	<b>Sharpness (-7 to +7)</b> Adjusts the sharpness of the edges of the horizontal lines.
⑪	<b>Color (-7 to +7)</b> Adjust the shade of the picture's color.
⑫	<b>Gamma (0 to +5)</b> Emphasis of outlines.

### U3

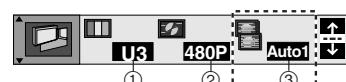

Only when "PROG." is on

①-③ (→ above)

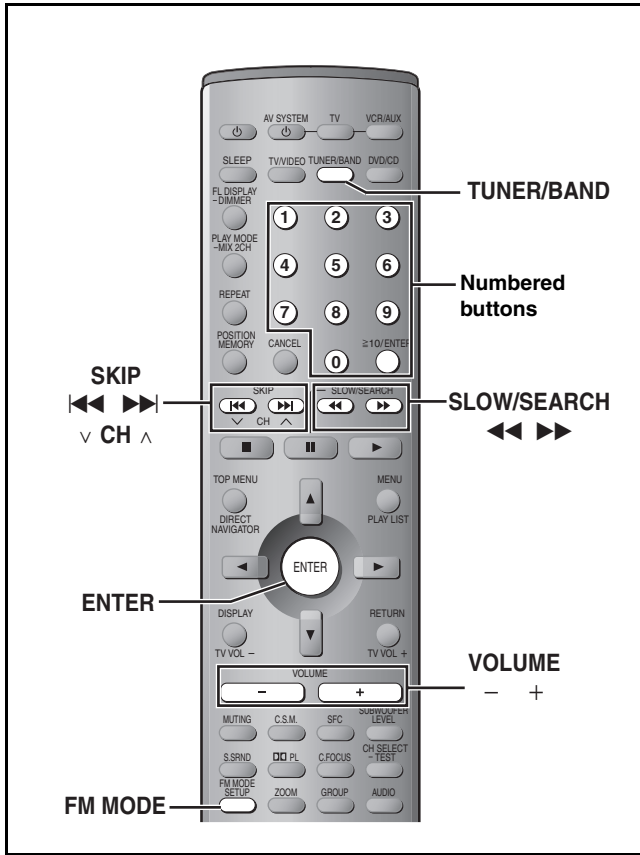

## Manual tuning

- 1** Press [TUNER/BAND] to select “FM” or “AM”.
- 2** Press [◀◀] or [▶▶] to select the frequency of the required station.  
 TUNED: Displayed when a radio station is tuned.  
 ST: Displayed when a stereo FM broadcast is being received.  

- 3** Adjust the volume.

■ **If noise is excessive in FM**  
 Press [FM MODE] to display “MONO”.



Press [FM MODE] again to cancel the mode. The mode is also canceled when you changed the frequency.

■ **FM frequency step**  
 The step is factory-set to 0.2 MHz, but you can change it to receive broadcasts allocated 0.1-MHz steps.

- 1 Press [TUNER/BAND] to select “FM”.
- 2 Press and hold [TUNER/BAND].

After a few seconds the display changes to show the current minimum frequency. Continue to hold the button down. The minimum frequency changes and the step is changed.

To return to the original step, repeat the above steps.

**Note**  
 Any FM frequencies preset in channels will be changed by this procedure. Preset them again.

## Preset tuning

Preset channels to make selection simple. Up to 15 stations can each be set in the FM and AM bands.

### Automatic presetting

- 1** Tune to “FM 87.9 MHz” or “FM 87.5 MHz” (⇒ left).
- 2** Press and hold [ENTER].  
 Release the button when “FM AUTO” is displayed.  
 The tuner presets all the stations it can receive into the channels in ascending order. “SET OK” is displayed when the stations are set. The last station to be set is then played.
- 3** Tune to “AM 520 kHz”.
- 4** Press and hold [ENTER].

■ **“ERROR” is displayed**  
 Presetting was unsuccessful. Preset manually.

### Manual presetting

- 1** Tune to the station (⇒ left).
- 2** Press [ENTER].
- 3** While “PGM” is flashing  
 Press the numbered buttons to select a channel.  
 Alternatively, press [◀◀, √ CH] or [▶▶, CH ^] then press [ENTER].



The station occupying a channel is erased if another station is preset in that channel.

### Selecting channels

- 1** Press [TUNER/BAND] to select “FM” or “AM”.
- 2** Press the numbered buttons or [◀◀, √ CH] or [▶▶, CH ^] to select the channel.

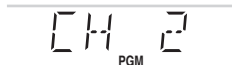

**To select a 2-digit number**  
 Example: To select channel 12, press [≥10] ⇒ [1] ⇒ [2]



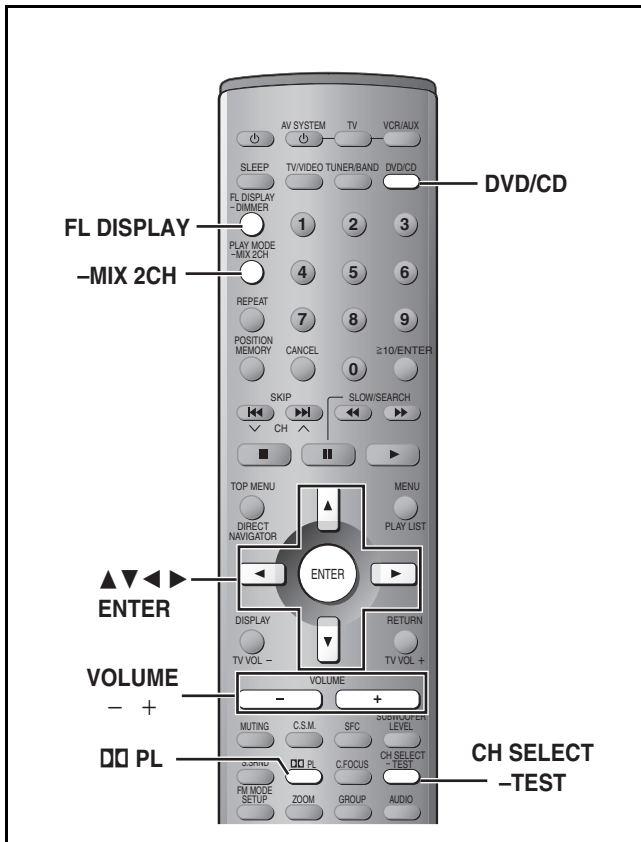

- Dolby Pro Logic, Super Surround, Center Focus and Subwoofer Level adjusting (➡ page 27) cannot be used if headphones are connected (“ERROR” appears on the display).
- You may experience a reduction in sound quality when these sound field systems are used with some sources. If this occurs, turn the sound field system off.

## Dolby Digital and DTS

- Dolby Digital and DTS are digital encoding systems used on DVD to carry surround sound. Both were originally developed for use in cinemas.
- This unit automatically recognizes and decodes these systems.

Software encoded with Dolby Digital can be identified with this mark.



Software encoded with DTS can be identified with this mark.



### Play a Dolby Digital or DTS source.

The Dolby Digital or DTS indicator lights.



### ■ To down-mix Dolby Digital or DTS (multiple-channel) signals to 2 channels

Press and hold [-MIX 2CH].

MIX 2CH ON

To cancel, press and hold [-MIX 2CH] again.

#### To check the current setting

Press [FL DISPLAY].

#### When “D.MIX” flashes on the display **DVD-A**

The DVD-Audio contains multiple-channel signals that cannot be down-mixed.

## Dolby Pro Logic

Dolby Pro Logic is a decoding system that was developed to get a better sense of presence from sources encoded with Dolby Surround. The feeling of position has been improved by the addition of a separate center speaker channel.

Software encoded with Dolby Surround can be identified with this mark (DVD, CD, Video CD, Laser Disc, Video tape).



**1** Press [DDPL].



**2** Play a Dolby Surround source.

#### To cancel

Press [DDPL] again.

#### Note

This does not work when playing multi-channel Dolby Digital.

## Speaker level adjustments

If the level of the speakers appears to be different while listening to a source, adjust the level of the speakers to the same apparent level.

#### Preparation

- Press [DVD/CD].

**1** Press and hold [-TEST] to output a test signal.

Lch: Front left  
Cch: Center  
Rch: Front right  
RSch: Right surround  
LSch: Left surround

**2** Press [VOLUME, +] or [-] to set the volume level normally used for enjoying the source.

**3** Press [▲] (to increase) or [▼] (to decrease).

L, R: -16 dB to 0 dB  
C, RS, LS: -10 dB to +6 dB

To stop the test signal, press and hold [-TEST] again.

#### ■ To adjust speaker level during play

**1** Press [CH SELECT] to select the speaker.

Lch→Cch→Rch→RSch→LSch→SWch

SWch: Subwoofer

- You can only adjust SWch if the disc includes a subwoofer channel.

**2** Press [▲] (to increase) or [▼] (to decrease).

L, R: -16 dB to 0 dB  
C, RS, LS: -10 dB to +6 dB  
SW: -10 dB to +10 dB

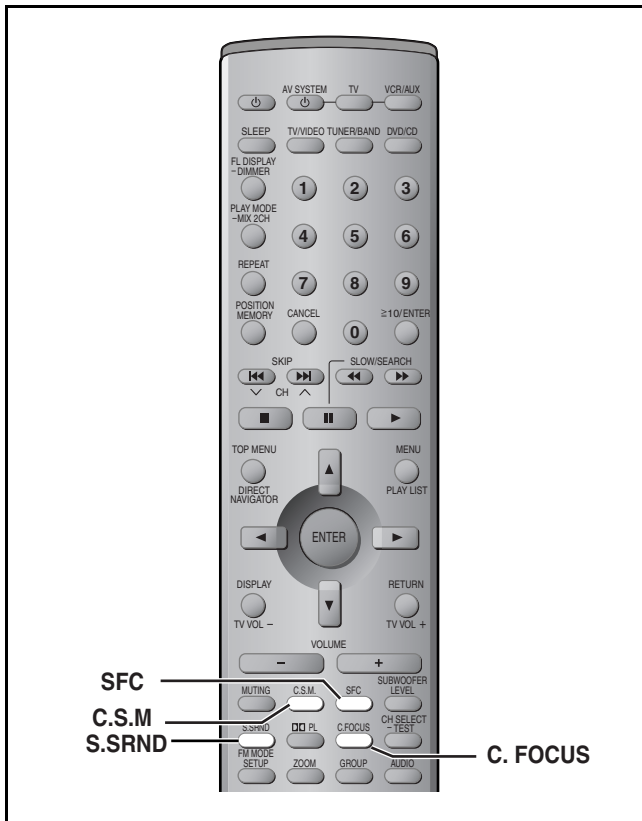

## Super Surround

Add surround effects to stereo sound.

Press **[S.SRND]**.



Each time you press the button:  
MUSIC → MOVIE → OFF

- You can adjust the volume of the surround speakers to get the best surround effect (➡ page 25, Speaker level adjustments).

### Note

- Turn Super Surround off when playing a DVD recorded with Dolby Digital or DTS. The surround effects will not be reproduced correctly if this is left on.
- Dolby Pro Logic (➡ page 25) switches off.

## Sound Field Control

Press **[SFC]** to select a setting.



Each time you press the button:

- HEAVY:** Adds punch to rock.
- CLEAR:** Clarifies higher sounds.
- SOFT:** For background music.
- DISCO:** Reverberates sound to make you feel like you were in a disco.
- LIVE:** Makes vocals more alive.
- HALL:** Expands sound to make you feel like you were in a hall.
- FLAT:** Canceled (no effect is added) (factory preset).

To check the current setting

Press **[SFC]**.

## Center Focus

You can make the sound of the center speaker seem like it is coming from within the television.

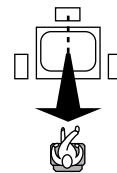

Press **[C.FOCUS]**.



Each time you press the button:

CENTER FOCUS 1 (Normal) → CENTER FOCUS 2 (Enhanced)  
↑ OFF ↓

- This does not work when Super Surround is turned on.
- This will have less effect when Dolby Pro Logic is turned on.

## Custom Sound Memory—Store the sound settings

DVD-A DVD-V VCD CD

Store the sound settings for a disc so the unit recalls them the next time you play it.

- Number of discs: 30
- Settings: Dolby Pro Logic, Subwoofer level, Center Focus, Sound Field Control, Super Surround

### Store the settings

**1 Make the settings.**

**2 Press and hold [C.S.M].**



### Recall the settings

The unit recalls the settings when you play the disc again.

- The settings are replaced if you change them.
- When you store settings for a 31st disc, the earliest settings disappear.
- Press **[C.S.M]** while “CSM” is lit and the settings return to those that were on before the settings are recalled.
- Press **[C.S.M]** while “CSM” is out and you are playing a disc for which you stored settings and those settings are recalled.

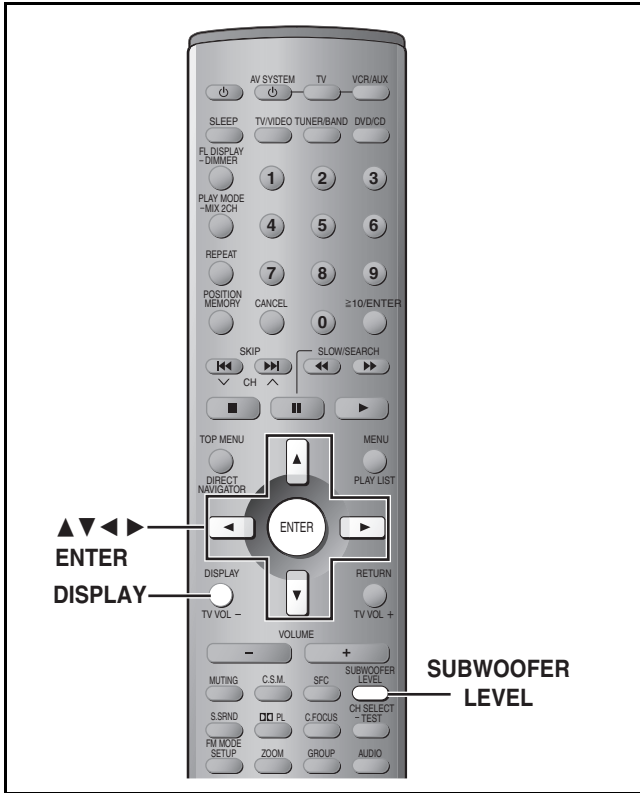

## Adjusting the bass

Press [SUBWOOFER LEVEL].

SUB W 2

Each time you press the button:  
SUB W 1 → SUB W 2 → SUB W 3 → SUB W 4 (factory preset)

## Re-master— Enjoying more natural sound

**RAM DVD-A DVD-V CD**

**Discs recorded with 2-channel LPCM at 44.1 kHz or 48 kHz**

This feature gives you a more natural sound by adding the higher frequency signals not recorded on the disc.

**WMA MP3**

**Discs recorded at 44.1 kHz or 48 kHz**

This feature reproduces the frequencies lost during recording to give you a sound closer to the original.

- 1 During play  
Press [DISPLAY] until the unit information screen is displayed  
(⇒ page 22).

- 2 Press [▲, ▼] to select the audio menu.



Re-master

- 3 Press [◀, ▶] to select “Re-master”.
- 4 Press [▲, ▼].

Each time you press the button:

Setting	<b>RAM DVD-A DVD-V CD</b> Type of music	<b>WMA MP3</b> Effect level
1	High tempo (e.g., pops and rock)	Light
2	Various tempos (e.g., jazz)	Medium
3	Low tempo (e.g., classical)	Strong
OFF	Off	Off

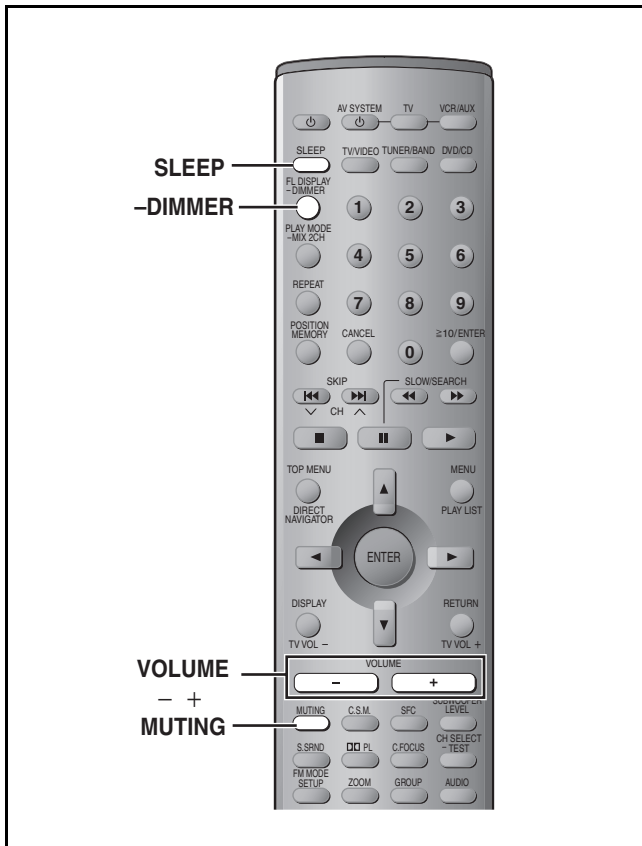

## Muting the volume

Press [MUTING].



Volume is reduced to minimum.

### To cancel

Press [MUTING] again or reduce the volume to minimum (--- dB), then raise it to the required level. Muting is also canceled when you switch the unit to standby.

## Dimming the display

Press and hold [-DIMMER].

To return to the original brightness, press and hold [-DIMMER] again. The display also returns to the original brightness when you switch the unit to standby.

## The sleep timer

This timer turns the unit off after a set time.

Press [SLEEP] to select the time (minutes).



Each time you press the button:

SLEEP 30 → SLEEP 60 → SLEEP 90  
 ↑ SLEEP OFF ← SLEEP 120 ←

### To cancel the timer

Press [SLEEP] to select "SLEEP OFF".

### To check the SLEEP setting

Press [SLEEP] once.

• The time remaining appears.

### To change the setting

Press [SLEEP] to display the remaining time, then press again to select the required time.

## Using headphones

**1 Reduce the volume and connect the headphones (not included).**

Headphone plug type: 3.5 mm (1/8") stereo

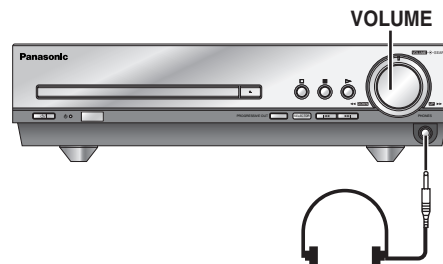

**2 Adjust headphone volume with [VOLUME].**

Audio is automatically switched to stereo (2-channel).





### Note

Avoid listening for prolonged periods of time to prevent hearing damage.

# Changing settings

This chart shows the settings for this unit. Change the settings to suit your preferences and to suit the unit to the environment in which it is being used. These settings are retained in memory until they are changed, even if the unit is turned off. See page 30 for details on menu operation.

• Underlined items are the factory preset.

Menus	Items	Options
<b>Disc</b> 	<b>Audio</b> Choose the preferred audio language.	<u>English</u> French   Spanish   Original   Other **** Original:        The original language of each disc will be selected. Other ****:    Input a code number with the numbered buttons (⇒ page 31).
	<b>Subtitle</b> Choose the preferred subtitle language.	<u>Automatic</u> English   French   Spanish   Other **** Automatic:    If the language selected for "Audio" is not available, subtitles of that language will automatically appear if available on that disc.
	<b>Menus</b> Choose the preferred language for disc menus.	<u>English</u> French   Spanish   Other ****
	<b>Ratings</b> (⇒ page 30) Set a ratings level to limit DVD-Video play. • The password screen is shown if you choose levels 0 to 7 or if you choose "Ratings" when levels 0 to 7 have been selected. • Select "Level 0" to prevent play of discs that do not have ratings levels recorded on them.	<b>Setting ratings (When level 8 is selected)</b> <u>8 No Limit</u> : All DVD-Video can be played. 1 to 7:        Prohibits play of DVD-Video with corresponding ratings recorded on them. 0 Lock All:    Prohibits play of all DVD-Video. ----- <b>Changing ratings (When level 0–7 is selected)</b> Unlock Player        Change Level Change Password    Temporary Unlock
<b>Video</b> 	<b>TV Aspect</b> (⇒ page 11) Choose the setting to suit your television and preference.	<u>4:3 Pan&amp;Scan</u> 4:3 Letterbox        16:9
	<b>TV Type</b> (⇒ page 11) Select to suit the type of television.	<u>Standard (Direct View TV)</u> CRT Projector        LCD TV/Projector Projection TV         Plasma TV
	<b>Still Mode</b> Specify the type of picture shown when paused.	<u>Automatic</u> Field        Frame
	<b>Black Level Control</b> Change the black level of the picture if you connected a television through the COMPONENT VIDEO OUT terminals.	<b>Lighter</b> : when connected to a TV through the VIDEO OUT or S VIDEO OUT terminal. <b>Darker</b> : when connected to a TV through the COMPONENT VIDEO OUT (Y/P <sub>B</sub> /P <sub>R</sub> ) terminals.
<b>Audio</b> 	<b>Speaker Setting</b> (⇒ page 30) Set the delay time for your center and surround speakers.	Multi-channel Center:                0/1.3/2.6/3.9/5.3 ms Surround (L/R):      0/5.3/10.6/15.9 ms
	<b>Dynamic Range Compression</b> (Dolby Digital only) Change the dynamic range for late night viewing.	<u>Off</u> On: For clear dialog when listening at low volume.
	<b>Audio during Search</b> Choose whether to have sound during search.	<u>On</u> Off • This feature doesn't work for some discs.
<b>Display</b> 	<b>Menu Language</b> Choose the preferred language for these menus and the on-screen messages.	<u>English</u> Français        Español
	<b>On-Screen Messages</b> Choose whether to show on-screen messages or not.	<u>On</u> Off
<b>Others</b> 	<b>DVD-Video Mode</b> Select how to play pictures contained on some DVD-Audio. The setting returns to "Off" when you remove the disc, turn the unit off or change the source.	<u>Off</u> : DVD-Audio are played as DVD-Audio. On: DVD-Video contents found on DVD-Audio can be played.
	<b>QUICK SETUP</b> (⇒ page 11) Answer questions to make basic settings.	Yes (Menu language, Audio language, Subtitle language, TV type, TV aspect) <u>No</u>

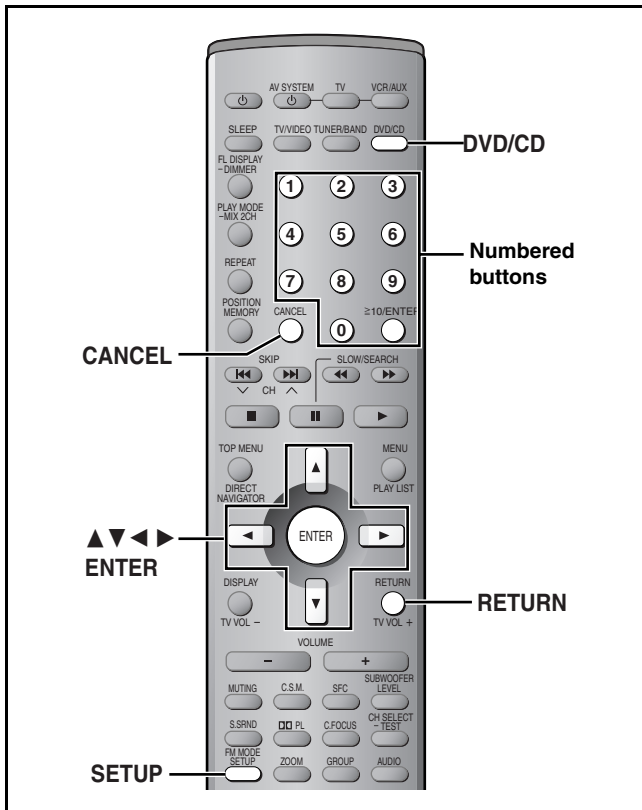

## Entering a password (Ratings)

### DVD-V

The password screen is shown when you select levels 0 to 7.

- Input a 4-digit password with the numbered buttons and press [ENTER].
  - If you enter a wrong number, press [CANCEL] to erase it before you press [ENTER].
  - The lock symbol appears closed to show the rating is locked.
  - Do not forget your password.**
- Press [ENTER] to confirm the 4 digits.

Now, when you insert a DVD-Video that exceeds the ratings limit you set, a message appears on the television. Follow the on-screen instructions.

## Changing the delay time (Speaker Setting)

### DVD-V

(Center and surround speakers only)

For optimum listening with 5.1-channel sound, all the speakers, except for the subwoofer, should be the same distance from the seating position. If you have to place the center or surround speakers closer to the seating position, adjust the delay time to make up for the difference.

Center delay time

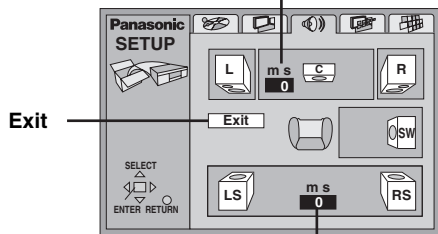

Surround delay time

- Press [▲, ▼, ◀, ▶] to select the delay time box and press [ENTER].
- Press [▲, ▼] to adjust the delay time and press [ENTER].

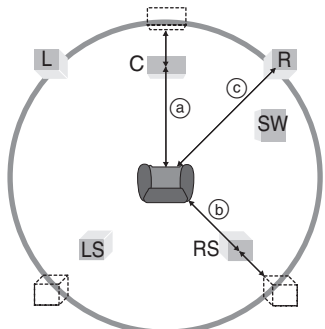

### Values

If distance (a) or (b) is greater than or equal to distance (c), set to "0".  
If distance (a) or (b) is less than distance (c), set as follows.

#### a) Center speaker

Difference	Setting
Approx. 50 cm (1 1/2 feet)	1.3 ms
Approx. 100 cm (3 feet)	2.6 ms
Approx. 150 cm (5 feet)	3.9 ms
Approx. 200 cm (6 feet)	5.3 ms

#### b) Surround speakers

Difference	Setting
Approx. 200 cm (6 feet)	5.3 ms
Approx. 400 cm (12 feet)	10.6 ms
Approx. 600 cm (18 feet)	15.9 ms

### When you are finished

Press [▲, ▼, ◀, ▶] to select "Exit" and press [ENTER].

## Common procedures

See page 29 for menu and option details.

### Preparation

Press [DVD/CD].

- Press [SETUP] to show the menus.

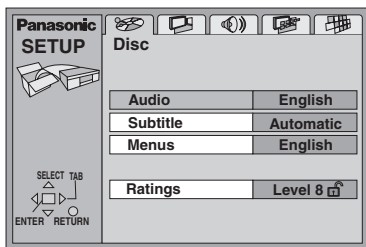

- Press [◀, ▶] to select the menu's tab.

The screen changes to display the menu.

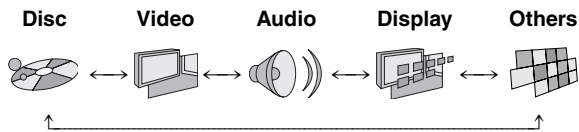

- Press [▲, ▼] to select the item you want to change and press [ENTER].

- Press [▲, ▼, ◀, ▶] to select the option and press [ENTER].

The screen now shows the menu again.

### To return to the previous screen

Press [RETURN].

### When you are finished

Press [SETUP].

# Language code list

Abkhazian: 6566	Chinese: 9072	Hausa: 7265	Lithuanian: 7684	Romanian: 8279	Telugu: 8469
Afar: 6565	Corsican: 6779	Hebrew: 7387	Macedonian: 7775	Russian: 8285	Thai: 8472
Afrikaans: 6570	Croatian: 7282	Hindi: 7273	Malagasy: 7771	Samoan: 8377	Tibetan: 6679
Albanian: 8381	Czech: 6783	Hungarian: 7285	Malay: 7783	Sanskrit: 8365	Tigrinya: 8473
Ameharic: 6577	Danish: 6865	Icelandic: 7383	Malayalam: 7776	Scots Gaelic: 7168	Tonga: 8479
Arabic: 6582	Dutch: 7876	Indonesian: 7378	Maltese: 7784	Serbian: 8382	Turkish: 8482
Armenian: 7289	English: 6978	Interlingua: 7365	Maori: 7773	Serbo-Croatian: 8372	Turkmen: 8475
Assamese: 6583	Esperanto: 6979	Irish: 7165	Marathi: 7782	Shona: 8378	Twi: 8487
Aymara: 6588	Estonian: 6984	Italian: 7384	Moldavian: 7779	Sindhi: 8368	Ukrainian: 8575
Azerbaijani: 6590	Faroese: 7079	Japanese: 7465	Mongolian: 7778	Singhalese: 8373	Urdu: 8582
Bashkir: 6665	Fiji: 7074	Javanese: 7487	Nauru: 7865	Slovak: 8375	Uzbek: 8590
Basque: 6985	Finnish: 7073	Kannada: 7578	Nepali: 7869	Slovenian: 8376	Vietnamese: 8673
Bengali; Bangla: 6678	French: 7082	Kashmiri: 7583	Norwegian: 7879	Somali: 8379	Volapük: 8679
Bhutani: 6890	Frisian: 7089	Kazakh: 7575	Oriya: 7982	Spanish: 6983	Welsh: 6789
Bihari: 6672	Galician: 7176	Kirghiz: 7589	Pashto, Pushto: 8083	Sundanese: 8385	Wolof: 8779
Breton: 6682	Georgian: 7565	Korean: 7579	Persian: 7065	Swahili: 8387	Xhosa: 8872
Bulgarian: 6671	German: 6869	Kurdish: 7585	Polish: 8076	Swedish: 8386	Yiddish: 7473
Burmese: 7789	Greek: 6976	Laotian: 7679	Portuguese: 8084	Tagalog: 8476	Yoruba: 8979
Byelorussian: 6669	Greenlandic: 7576	Latin: 7665	Punjabi: 8065	Tajik: 8471	Zulu: 9085
Cambodian: 7577	Guarani: 7178	Latvian, Lettish: 7686	Quechua: 8185	Tamil: 8465	
Catalan: 6765	Gujarati: 7185	Lingala: 7678	Rhaeto-Romance: 8277	Tatar: 8484	

## Optional antenna connections

Use outdoor antennas if radio reception is poor.

### Note

Disconnect the antenna when the unit is not in use.  
Do not use the outdoor antenna during an electrical storm.

### AM outdoor antenna (Using a vinyl wire)

Run a piece of vinyl wire horizontally across a window or other convenient location.

5–12 m  
(16–39 feet)

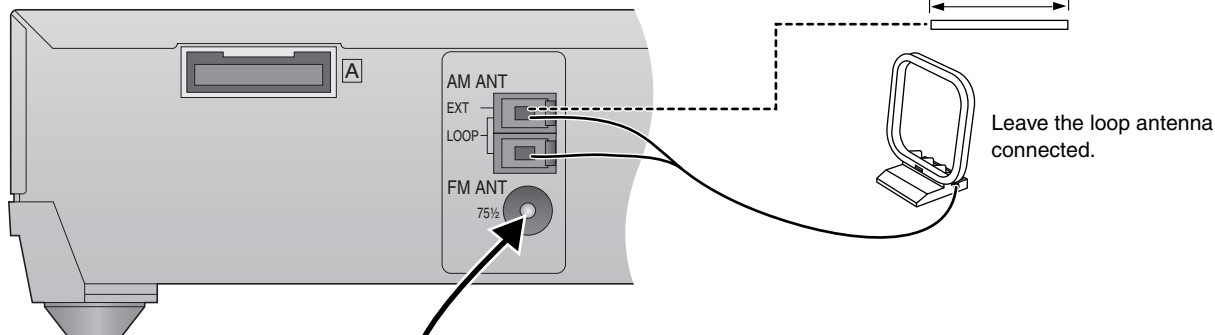

### FM outdoor antenna (Using a television antenna)

- Disconnect the FM indoor antenna.
  - The antenna should be installed by a competent technician.
- Rework your outdoor antenna's 75 Ω coaxial cable as follows.

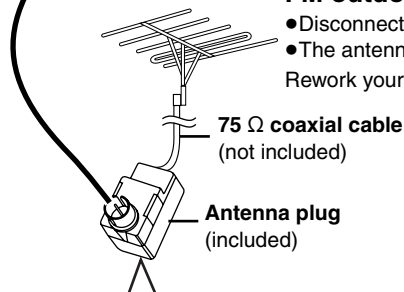

① Remove a piece of the outer vinyl insulator.

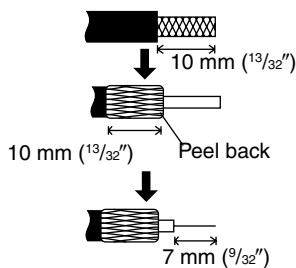

② Carefully pull the tabs apart to remove the cover.

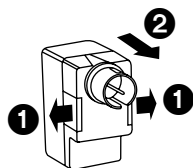

③ Install the coaxial cable.

Clamp the cable conductor, and wind it on so that it does not contact anything else.

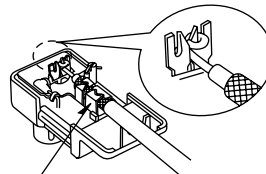

Clamp with pliers

④ Attach the cover.

# Operating a television or video cassette recorder

You can use the remote control to operate a Panasonic television or a video cassette recorder. (Some models cannot be operated by this remote control.)

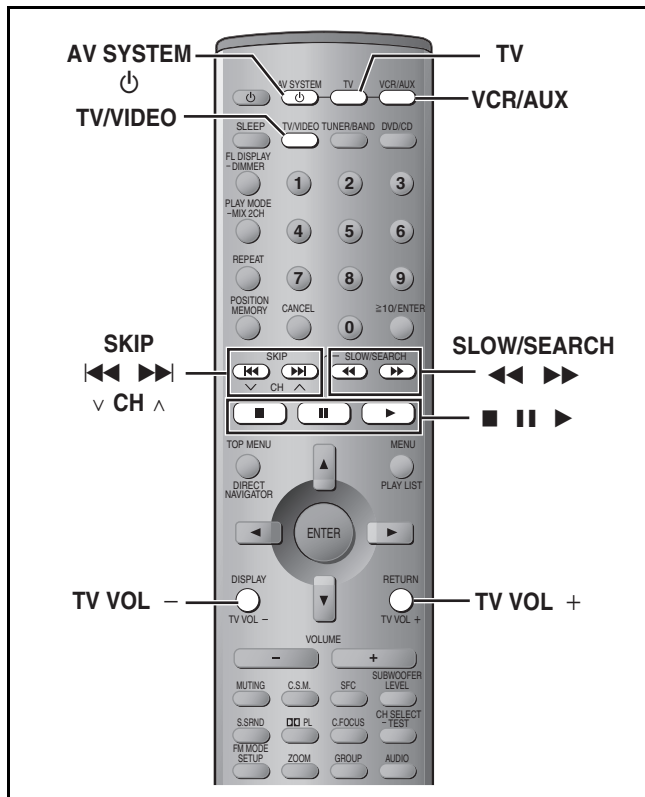

## Operating a television

### Preparation

- Face the remote control at this unit and press [TV]. The button lights and "TV" appears on the unit's display. You can now operate the television.
- Face the remote control at the television for the following operations.

### Turning the television on/off

Press [AV SYSTEM].

### Switching the television's video input mode

Press [TV/VIDEO].

### Changing channels

Press [SKIP, v CH] or [SLOW/SEARCH, CH ^].

### Adjusting the volume

Press [TV VOL+] or [TV VOL-].

### Playing the television through this unit's speakers

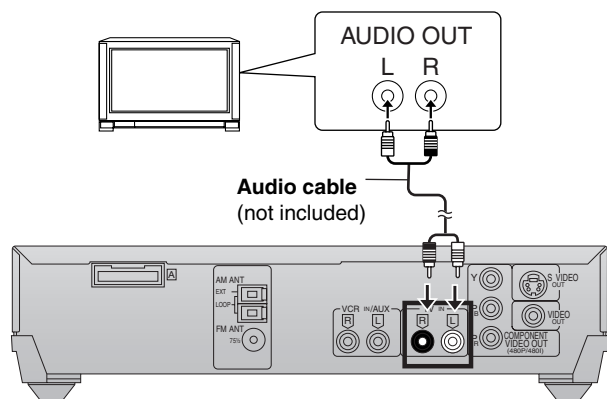

RQT6719 Reduce the volume on the television to minimum and control the volume on this unit.

## Operating a video cassette recorder

### Connection example

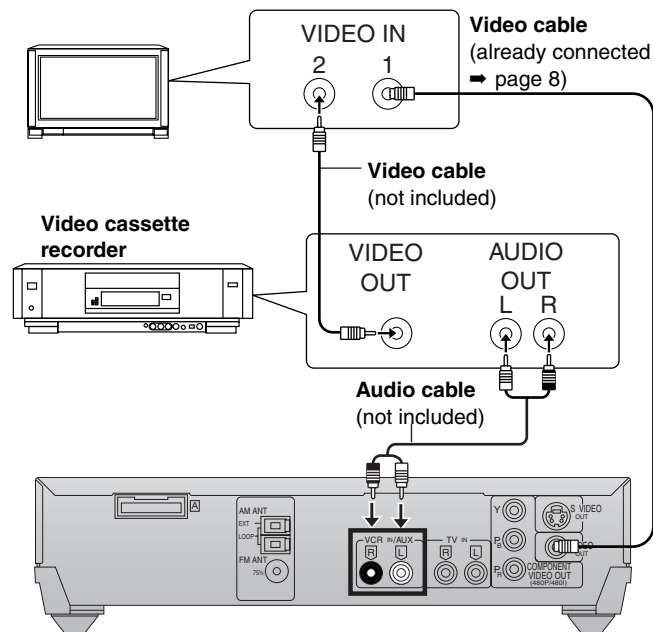

### Preparation

- Face the remote control at this unit and press [VCR/AUX]. The button lights and "VCR/AUX" appears on the unit's display. You can operate the video cassette recorder.
- Change the video input mode on the television ("VIDEO 2" in the example).
- Face the remote control at the video cassette recorder for the following operations.

### Turning the video cassette recorder on/off

Press [AV SYSTEM].

### Play, pause and stop

Press [▶], [⏸] or [■].

### Fast forward and rewind

Press [⏩] or [⏪].

### You can connect a laser disc or record player instead of a video cassette recorder.

Connect as shown above and select "VCR/AUX" as the source.

### When connecting a record player

We recommend using a record player with a built-in phono equalizer. If your player doesn't have a built-in equalizer, connect it first to a separate equalizer and then connect that to this unit.



## Changing the remote control code

The remote control can also operate some other brands of televisions and video cassette recorders. Change the code to operate such equipment and some Panasonic products.

While aiming the remote control at the equipment,  
**Press and hold [TV] or [VCR/AUX],**  
**Press a numbered button to enter the first digit,**  
**Press a numbered button to enter the second digit.**

The remote control outputs the on/off signal.  
 If the code is correct, the equipment turns on or off.  
 If it doesn't, try entering another code.

- Note that this remote control cannot operate some equipment and that it may not be able to perform some operations.
- Reenter the codes after you change the batteries.

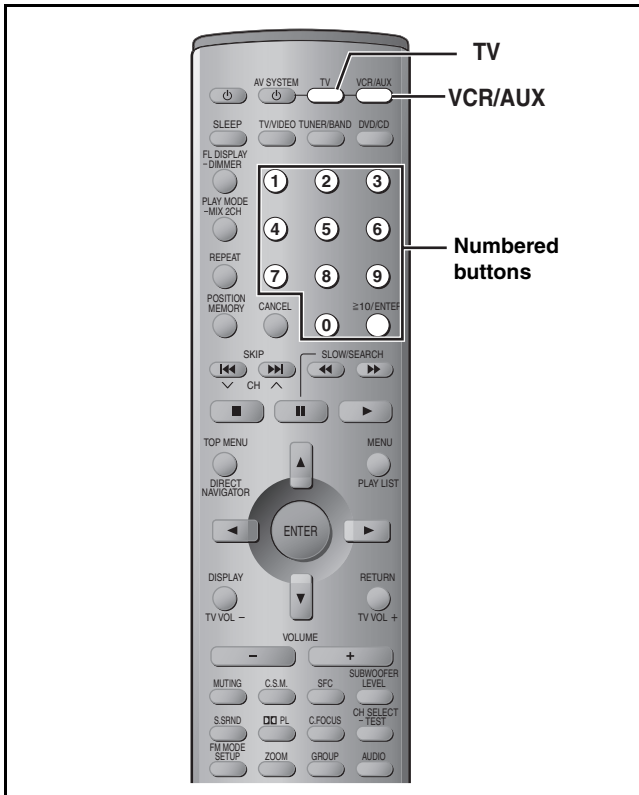

### Television code list

Panasonic: 01, 02, 26	Philco: 06, 07
Sony: 04	Philips: 06
Fisher: 14	Pioneer: 02, 10, 19
G-E: 02, 03, 07, 09	Quasar: 02
Gold Star: 07, 15	RCA: 03, 07, 09, 13, 23, 24, 25
Hitachi: 05, 07	Sanyo: 14
JVC: 12	Sharp: 08, 21
LXI: 03, 06, 07, 10, 14, 15	Sylvania: 06, 07, 15
Magnavox: 06, 07, 11, 15, 22	Symphonic: 17
Mitsubishi: 07, 15, 16, 21	Toshiba: 10, 21
NEC: 07, 15	Zenith: 18, 20

### Video cassette recorder code list

Panasonic: 01, 02, 09, 33	Philco: 02, 09, 12, 30
Sony: 05, 06, 07, 35, 36, 37	Philips: 02, 09, 12
Fisher: 13, 14, 15, 18, 34	Pioneer: 09
Funai: 08, 30	Quasar: 01, 02, 09, 33
G-E: 02, 03, 11	RCA: 02, 03, 04, 09, 10, 11, 12, 23, 24, 26
Gold Star: 27	Sanyo: 14, 18, 34
Hitachi: 09, 10, 11	Sharp: 16, 17
JVC: 19, 25, 31, 38, 39, 40	Shintom: 32
LXI: 10, 13, 14, 15, 18, 27, 30	Sylvania: 02, 09, 12, 30
Magnavox: 02, 09, 12	Symphonic: 30
Mitsubishi: 21, 22, 28, 29	Toshiba: 23, 24
NEC: 19, 25, 31, 38	Zenith: 20

## Decoder

A decoder restores the coded audio signals on DVDs to normal. This is called decoding.

## Dolby Digital

This is a method of coding digital signals developed by Dolby Laboratories. Apart from stereo (2-channel) audio, these signals can also be multi-channel audio. A large amount of audio information can be recorded on one disc using this method.

## Dolby Pro Logic

A surround system where a 4-channel audio track is recorded as 2 channels and then is restored to 4 channels for play. The surround channel is monaural and can reproduce up to 7 kHz.

## DTS (Digital Theater Systems)

This surround system is used in many movie theaters around the world. There is good separation between the channels, so realistic sound effects are possible.

## Dynamic range

Dynamic range is the difference between the lowest level of sound that can be heard above the noise of the equipment and the highest level of sound before distortion occurs.

## Film and video

DVD-Videos are recorded using either film or video. Usually, film is recorded at 24 frames per second, the rate movies are filmed at, while video is recorded at 30 frames per second.

## Frame still and field still

Frames are the still pictures that go together to make a moving picture. There are about 30 frames shown each second. One frame is made up of two fields. A regular television shows these fields one after the other to create frames. A still is shown when you pause a moving picture. A frame still is made up of two alternating fields, so the picture may appear blurred, but overall quality is high. A field still is not blurred, but it has only half the information of a frame still so picture quality is lower.

## Interlace and progressive output

NTSC, the video signal standard, has 480 interlaced (I) scan lines, whereas progressive scanning uses twice the number of scan lines. This is called 480P. The video signals output from this unit's COMPONENT VIDEO OUT terminals (Y, P<sub>B</sub>, P<sub>R</sub>) allow you to enjoy higher quality pictures than if the signals were output from the VIDEO OUT terminal or S VIDEO OUT terminal.

## I/P/B

MPEG 2, the video compression standard adopted for use with DVD-Video, codes frames using these 3 picture types.

### I: Intra coded picture

This picture has the best quality and is the best to use when adjusting the picture.

### P: Predictive coded picture

This picture is calculated based on past I or P-pictures.

### B: Bidirectionally-predictive coded picture

This picture is calculated by comparing past and future I and P-pictures so it has the lowest volume of information.

## Linear PCM (pulse code modulation)

These are uncompressed digital signals, similar to those found on CDs.

## Playback control (PBC)

If a Video CD has playback control, you can select scenes and information with menus.

## WMA, MP3, and CD text information

- Discs must conform to ISO9660 level 1 or 2 (except for extended formats).
- This unit is compatible with multi-session but if there are a lot of sessions it takes more time for play to start. Keep the number of sessions to a minimum to avoid this.
- The order tracks appear in the menus may differ to the order shown on your computer.

### WMA

- Noise may occur when playing WMA files.
- You cannot play WMA files that are copy protected.

### MP3

- This unit is not compatible with ID3 tags.
- If you play an MP3 track that includes still picture data, it will take some time before the music itself starts playing and the elapsed time will not be displayed during this time. Even after the track starts, the correct play time will not be displayed.

## Order of play

WMA MP3

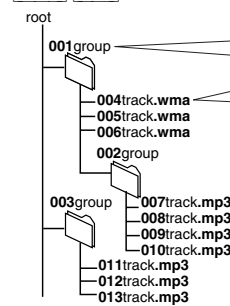

### Naming folders and files

Prefix folder and file names with 3-digit numbers in the order you want to play them.

Extension  
004track.wma (or .WMA)

The extension for MP3 is ".mp3" or ".MP3".

### CD (CD text only)

#### When making your own CD text discs

The unit plays the tracks in the order you record them so you do not have to prefix the titles with numbers.

Windows Media, and the Windows logo are trademarks, or registered trademarks of Microsoft Corporation in the United States and/or other countries.

WMA is a compression format developed by Microsoft Corporation. It achieves the same sound quality as MP3 with a file size that is smaller than that of MP3.



MPEG Layer-3 audio decoding technology licensed from Fraunhofer IIS and Thomson multimedia.

## AMPLIFIER SECTION

<b>RMS Output Power: Dolby Digital Mode, 10 % Total Harmonic Distortion</b>	
1 kHz Front CH	55 W per channel 6 Ω
1 kHz Surround CH	55 W per channel 6 Ω
1 kHz Center CH	160 W per channel 6 Ω
100 Hz Subwoofer CH	220 W per channel 4 Ω
<b>Total RMS Dolby Digital Mode Power</b>	600 W
<b>RMS Output Power Stereo Mode:</b>	
1 kHz Front CH	45 W per channel 6 Ω
100 Hz Subwoofer CH	220 W per channel 4 Ω
<b>Total RMS Stereo Mode Power</b>	310 W
<b>FTC Output Power: Dolby Digital Mode, 1 % Total Harmonic Distortion</b>	
120 Hz–20 kHz Front CH	30 W per channel 6 Ω
120 Hz–20 kHz Surround CH	30 W per channel 6 Ω
120 Hz–20 kHz Center CH	110 W per channel 6 Ω
45 Hz–120 Hz Subwoofer CH	140 W per channel 4 Ω
<b>Total FTC Dolby Digital Mode Power</b>	370 W
<b>FTC Output Power Stereo Mode:</b>	
120 Hz–20 kHz Front CH	25 W per channel 6 Ω
45 Hz–120 Hz Subwoofer CH	140 W per channel 4 Ω
<b>Total FTC Stereo Mode Power</b>	190 W
<b>Input sensitivity/Input impedance</b>	
AUX	350 mV, 10 kΩ

## FM TUNER SECTION

<b>Frequency range</b>	87.9–107.9 MHz (200-kHz step)
	87.5–108.0 MHz (100-kHz step)
<b>Sensitivity</b>	2.5 μV (IHF)
S/N 26 dB	2.2 μV
<b>Antenna terminals</b>	75 Ω (unbalanced)
<b>Preset station</b>	15

## AM TUNER SECTION

<b>Frequency range</b>	520–1710 kHz (10-kHz step)
<b>AM Sensitivity S/N 20 dB at 1000 kHz</b>	560 μV/m
<b>Preset station</b>	15

## DISC SECTION

<b>Disc played</b>	(one layer per side)
DVD-Audio/Video	8 cm/12 cm, single/double-sided, single/double-layer
<b>DVD-RAM/R (DVD-Video formatted discs)</b>	
CD (CD-DA), Video-CD	
CD/VCD/MP3/WMA	8 cm/12 cm, CD-R/RW
<b>Video</b>	
<b>Signal system</b>	NTSC
<b>Output level</b>	Composite video 1 Vp-p (75 Ω) S-video Y 1 Vp-p (75 Ω) S-video C 0.286 Vp-p (75 Ω)
<b>Audio</b>	
<b>Sampling frequency</b>	
CD	44.1 kHz
MP3	32 kHz, 44.1 kHz, 48 kHz
DVD	48 kHz, 96 kHz, 192 kHz
<b>Bitrate</b>	
MP3	32–320 kbps
<b>Decoding</b>	16/20/24 bit linear
<b>Pick up</b>	
<b>Beam Source</b>	Semiconductor Laser
<b>Wavelength</b>	
CD/VCD	780 nm
DVD	658 nm
<b>Number of channels</b>	5.1 ch (FL, FR, SL, SR, C, SW)
<b>Frequency response</b>	20 Hz–20 kHz (+1, –2 dB)
<b>Wow and flutter</b>	Less than possible measurement data
<b>Digital filter</b>	8 fs
<b>D/A converter</b>	Delta signal DAC

## SPEAKER SECTION

<b>Front/Surround speakers SB-FS801A</b>	
<b>Type</b>	1 way, 1 speaker, Bass-ref.
<b>Speakers</b>	
Full range	6.5 cm (2 <sup>1</sup> / <sub>2</sub> " cone type 6 Ω
<b>Input power</b>	60 W (Music)
<b>Output sound pressure level</b>	79 dB/W (1.0 m)
<b>Frequency range</b>	110 Hz–25 kHz (–16 dB) 130 Hz–22 kHz (–10 dB)
<b>Dimensions (W×H×D)</b>	110×226×133 mm (4 <sup>1</sup> / <sub>32</sub> "×8 <sup>29</sup> / <sub>32</sub> "×5 <sup>1</sup> / <sub>4</sub> " (With stand)
<b>Mass</b>	0.93 kg (2.1 lb.)

<b>Center speaker SB-PC700</b>	
<b>Type</b>	1 way, 2 speaker, Bass-ref.
<b>Speakers</b>	
Full range	6.5 cm (2 <sup>1</sup> / <sub>2</sub> " cone type 6 Ω
<b>Input power (with filter)</b>	220 W (Music)
<b>Output sound pressure level</b>	82 dB/W (1.0 m)
<b>Frequency range</b>	110 Hz–25 kHz (–16 dB) 130 Hz–22 kHz (–10 dB)
<b>Dimensions (W×H×D)</b>	250×140×145 mm (9 <sup>27</sup> / <sub>32</sub> "×5 <sup>1</sup> / <sub>2</sub> "×5 <sup>23</sup> / <sub>32</sub> " (With stand)
<b>Mass</b>	1.6 kg (3.5 lb.)

<b>Active subwoofer SB-WA340</b>	
<b>Type</b>	1 way, 1 speaker, Bass-ref.
<b>Speaker unit</b>	
Woofer	17 cm (6 <sup>3</sup> / <sub>4</sub> " cone type 6 Ω
<b>Input power</b>	240 W (Music)
<b>Output sound pressure level</b>	80 dB/W (1.0 m)
<b>Frequency range</b>	40 Hz–220 Hz (–16 dB) 45 Hz–180 Hz (–10 dB)
<b>Dimensions (W×H×D)</b>	160×450×424 mm (6 <sup>5</sup> / <sub>16</sub> "×17 <sup>23</sup> / <sub>32</sub> "×16 <sup>1</sup> / <sub>16</sub> "
<b>Mass</b>	12 kg (26.5 lb.)

## GENERAL

<b>Power supply</b>	AC 120 V, 60 Hz
<b>Power consumption</b>	SA-MT1 25 W SB-WA340 250 W
<b>Dimensions (W×H×D)</b>	280×76×316 mm (11"×3"×12 <sup>7</sup> / <sub>16</sub> ")
<b>Mass</b>	2.4 kg (5.3 lb.)

<b>Power consumption in standby mode (Subwoofer)</b>	0.5 W
--	-------

## Note

- Specifications are subject to change without notice. Mass and dimensions are approximate.
- Total harmonic distortion is measured by the digital spectrum analyzer.

# Troubleshooting guide

Before requesting service, make the below checks. If you are in doubt about some of the check points, or if the remedies indicated in the chart do not solve the problem:

**In the U.S.A., contact the Panasonic Customer Call Center at 1-800-211-7262, or e-mail [consumerproducts@panasonic.com](mailto:consumerproducts@panasonic.com), or web site (<http://www.panasonic.com>).**

**In Canada, contact Panasonic Canada Inc. Customer Care Centre at 1-800-561-5505, web site ([www.panasonic.ca](http://www.panasonic.ca)), or an authorized Servicentre closest to you.**

Power		Page
No power.	● Insert the AC power supply cord and system cable securely.	9
The unit is automatically switched to the standby mode.	● The unit was switched to standby by the sleep timer.	28

## Operation

No response when buttons pressed.	<ul style="list-style-type: none"> <li>● Some operations may be prohibited by the disc.</li> <li>● The unit may not be operating properly due to lightning, static electricity or some other external factor.</li> </ul> <p><b>Reset procedure:</b> Press [⏻] to switch the unit to the standby mode and then back to ON. Alternatively, press [⏻] to switch the unit to the standby mode, disconnect the AC power supply cord, and then reconnect it.</p>	— —
No operations can be performed with the remote control.	<ul style="list-style-type: none"> <li>● Check that the batteries are installed correctly.</li> <li>● The batteries are depleted: Replace them with new ones.</li> <li>● Point the remote control at the remote control sensor and operate.</li> </ul>	9 9 —
Cannot switch on the television with the remote control.	● Press [TV] first to operate the television.	—
Play doesn't start (or stops immediately) when you press [▶] (play).	<ul style="list-style-type: none"> <li>● Condensation has formed: Wait 1 to 2 hours for it to evaporate.</li> <li>● This unit cannot play discs other than the ones listed in these operating instructions.</li> <li>● This unit cannot play DVD-Video with a region number other than "1", "ALL" or multiple region numbers including "1".</li> <li>● The disc may be dirty and may require cleaning.</li> <li>● Ensure that the disc is installed with the label of the side to be played facing upwards.</li> <li>● Check that the DVD-RAM has something recorded on it.</li> </ul>	— 5 Cover 5 13 —
Cannot select alternative languages.	<ul style="list-style-type: none"> <li>● This function is dependent on software availability.</li> <li>● Try selecting from the disc's menu if one is available.</li> </ul>	— 14
No menu play.	● This function is dependent on software availability.	—
No subtitles.	<ul style="list-style-type: none"> <li>● This function is dependent on software availability.</li> <li>● Subtitles are cleared from the television. Display the subtitles.</li> </ul>	— 17
The position of the subtitles is incorrect.	● Change the position of the subtitles with "Subtitle Position" in the on-screen icon menus.	23
Soundtrack and/or subtitle language is not the one selected with the SETUP menus.	● This function is dependent on software availability.	—
Cannot change angle.	● This function is dependent on software availability. Even if a disc has a number of angles recorded, these angles may be recorded for specific scenes only.	—
The SETUP menu cannot be accessed.	<ul style="list-style-type: none"> <li>● Select "DVD/CD" as the source.</li> <li>● Cancel all group, program and random play.</li> </ul>	— 16
Cannot add markers.	● You cannot add markers while playing a play list or if the disc's play time doesn't appear on the unit's display.	—
There are already markers. <b>RAM</b>	● The unit reads and displays the markers added with a DVD video recorder. You can clear them but reappear when you switch the unit to standby, change the source, or open the disc tray.	—
Marker numbers I added are different when I call them up. <b>RAM</b>	● The unit numbers markers by time so they change when you add and delete them.	—
Cannot select random or program play.	● You cannot select random or program play with some DVD-Video.	—
Folders deeper than the eighth layer on a data CD are not displayed correctly.	● Folders deeper than the eighth layer are displayed as the eighth layer.	—
You have forgotten your ratings password. Reset all the SETUP settings to Factory Preset.	● While stopped and "DVD/CD" is the source, press and hold [■] on the unit and [≥10] on the remote control for about 3 seconds until "Initialized" disappears from the television. Turn the unit off and on again. All settings will return to the default values.	—

## Sound

<b>No sound. Distorted sound.</b>	<ul style="list-style-type: none"> <li>● Check the connections.</li> <li>● Turn the volume up.</li> <li>● Turn muting off.</li> <li>● Switch off the unit, determine and correct the cause, then switch the unit on. Causes include: <ul style="list-style-type: none"> <li>– Shorting (bare wires touching) of positive and negative speaker wires.</li> <li>– Using speakers with an impedance lower than that rated for this unit.</li> <li>– Straining of the speakers through excessive volume or power.</li> <li>– Using the unit in a hot environment without proper ventilation.</li> </ul> </li> </ul>	<p>7 — 28 —</p>
<b>Humming heard during play.</b>	<ul style="list-style-type: none"> <li>● An AC power supply cord or fluorescent light is near the subwoofer. Keep other appliances and cords away from the subwoofer.</li> </ul>	—

## Picture

<b>Picture distorted.</b>	<ul style="list-style-type: none"> <li>● Some distortion is normal during SEARCH.</li> </ul>	—
<b>No picture.</b>	<ul style="list-style-type: none"> <li>● Check the connection.</li> <li>● Make sure the television is on.</li> <li>● Ensure the television's video input setting (e.g., VIDEO 1) is correct.</li> </ul>	<p>8 — —</p>
<b>The picture shown on the television is not normal. (The sides of the picture are cut off, the picture is stretched horizontally, or black bands appear at the top and bottom of the screen.)</b>	<ul style="list-style-type: none"> <li>● Go to Video in the SETUP menus, and change "TV Aspect" to suit your television.</li> <li>● Use the television to change the aspect to the correct one. <b>If your television cannot change the aspect when input is progressive</b>, try changing 4:3 Aspect with the on-screen menu icons.</li> <li>● Ensure that the unit is connected directly to the television, and is not connected through a video cassette recorder.</li> <li>● Connect to the component video (480P) input terminals on a television compatible with this unit's copy guard system. You cannot view progressive video if your television is not compatible.</li> <li>● Change the size with the variable zoom function.</li> <li>● The images on PAL system DVD-Audio are compressed for display. They may also appear vertically stretched.</li> </ul>	<p>29 — 23 — 8 18 —</p>
<b>There is ghosting when progressive output is on.</b>	<ul style="list-style-type: none"> <li>● Press [PROGRESSIVE OUT] so the indicator goes out. This problem is caused by the editing method or material used on DVD-Video, but should be corrected if you use interlace output.</li> </ul>	13
<b>Picture quality is poor.</b>	<ul style="list-style-type: none"> <li>● Check the settings in the On-Screen Menu Icons' Picture Menu.</li> <li>● The "U1" settings do not work on the images from PAL system DVD-Audio.</li> </ul>	<p>23 23</p>
<b>The picture on the television disappears or stripes appear on the screen.</b>	<ul style="list-style-type: none"> <li>● Mobile telephone chargers can cause some disturbance.</li> <li>● The location and orientation of the antenna are incorrect. If you are using an indoor antenna, change to an outdoor antenna.</li> <li>● The television antenna wire is too close to the unit. Separate the antenna wire of the television from the unit.</li> </ul>	<p>— 31 —</p>
<b>Menus not displayed correctly.</b>	<ul style="list-style-type: none"> <li>● Change the zoom ratio to "× 1.00".</li> <li>● With the on-screen icon menus, change "Subtitle Position" to "0" or change "4:3 Aspect" to "Normal".</li> </ul>	<p>18 23</p>

## Listening to the radio

<b>Noise is heard. "ST" flickers or doesn't light. Sound is distorted.</b>	<ul style="list-style-type: none"> <li>● Adjust the position of the FM or AM antenna.</li> <li>● Use an outdoor antenna.</li> </ul>	<p>— 31</p>
<b>A beat sound is heard.</b>	<ul style="list-style-type: none"> <li>● Turn the television off or separate it from the unit.</li> </ul>	—
<b>A low hum is heard during AM broadcasts.</b>	<ul style="list-style-type: none"> <li>● Separate the antenna from other cables and cords.</li> </ul>	—

Unit displays

The display is dark.	● Press and hold [–DIMMER] to brighten the display.	28
“NO PLAY”	● You inserted a disc the unit cannot play; insert one it can. ● You inserted a blank DVD-RAM.	5 —
“NO DISC”	● You haven’t inserted a disc; insert one. ● You haven’t inserted the disc correctly; insert it correctly.	— 13
“F61”	● Check and correct the speaker cord connections. If this does not fix the problem, there is a power supply problem. Call 1-800-211-PANA.	7
“DVD U11”	● Disc is dirty. Wipe it clean.	5
“ERROR”	● Incorrect operation performed. Read the instructions and try again.	—
“DVD H□□” □□ stands for a number.	● Trouble may have occurred. The number following “H” depends on the status of the unit. <b>Reset procedure:</b> Press [⏻] to switch the unit to the standby mode and then back to ON. Alternatively, press [⏻] to switch the unit to the standby mode, disconnect the AC power supply cord, and then reconnect it. ● If the service numbers fail to clear, note the service number and contact a qualified service person.	— —

Television displays

No on-screen display.	● Go to Display in the SETUP menus, and select “On” for “On-Screen Messages”.	29
On-Screen Menu Icons not displayed or only partially displayed on the television.	● Press [▲, ▼] while the rightmost icon is highlighted to move them down.	21
The disc’s menu is displayed in a different language.	● Go to Disc in the SETUP menus, and select the preferred language for “Menus”.	29

Product Service

- 1. Damage requiring service**—The unit should be serviced by qualified service personnel if:
  - (a) The AC power supply cord or AC adaptor has been damaged; or
  - (b) Objects or liquids have gotten into the unit; or
  - (c) The unit has been exposed to rain; or
  - (d) The unit does not operate normally or exhibits a marked change in performance; or
  - (e) The unit has been dropped or the cabinet damaged.
- 2. Servicing**—Do not attempt to service the unit beyond that described in these operating instructions. Refer all other servicing to authorized servicing personnel.
- 3. Replacement parts**—When parts need replacing ensure the servicer uses parts specified by the manufacturer or parts that have the same characteristics as the original parts. Unauthorized substitutes may result in fire, electric shock, or other hazards.
- 4. Safety check**—After repairs or service, ask the servicer to perform safety checks to confirm that the unit is in proper working condition.

The servicer will require all components to service your system. Therefore, should service ever be necessary, be sure to bring the entire system.

Product information

For product information or assistance with product operation:

In the U.S.A., contact the Panasonic Customer Call Center at 1-800-211-7262, or e-mail [consumerproducts@panasonic.com](mailto:consumerproducts@panasonic.com), or web site (<http://www.panasonic.com>).  
In Canada, contact Panasonic Canada Inc. Customer Care Centre at 1-800-561-5505, web site ([www.panasonic.ca](http://www.panasonic.ca)), or an authorized Servicentre closest to you.

Maintenance

- To clean this unit, wipe with a soft, dry cloth.**
- Never use alcohol, paint thinner or benzine to clean this unit.
  - Before using chemically treated cloth, read the instructions that came with the cloth carefully.

**Before moving the unit, ensure the disc tray is empty.**  
**Failure to do so will risk severely damaging the disc and the unit.**

# Limited Warranty (U.S.A.)

Panasonic Consumer Electronics Company,  
Division of Matsushita Electric Corporation of America  
One Panasonic Way Secaucus, New Jersey 07094

Panasonic Sales Company, Division of Matsushita Electric of Puerto Rico, Inc.  
Ave. 65 de Infantería, Km. 9.5  
San Gabriel Industrial Park, Carolina, Puerto Rico 00985

## Panasonic/Technics Audio Products Limited Warranty

### Limited Warranty Coverage

If your product does not work properly because of a defect in materials or workmanship, Panasonic Consumer Electronics Company or Panasonic Sales Company (collectively referred to as "the warrantor") will, for the length of the period indicated on the chart below, which starts with the date of original purchase ("warranty period"), at its option either (a) repair your product with new or refurbished parts, or (b) replace it with a new or a refurbished product. The decision to repair or replace will be made by the warrantor.

Product or Part Name	Parts	Labor
Audio Products (except items listed below)	One (1) year	One (1) year
All Audio Racks (cabinets)	Thirty (30) days	Not Applicable
Technics Stand Alone Speakers, Subwoofer Speakers	Three (3) years	Three (3) years
USB Reader-Writer, Personal Computer Card Adapters (in exchange for defective item)	One (1) year	Not Applicable
Accessories: Headphones, Cartridges, Microphones, Adapters	Ninety (90) days	Ninety (90) days
Rechargeable Batteries (in exchange for defective item)	Ten (10) days	Not Applicable
SD Memory Cards, Rechargeable Battery Packs (in exchange for defective item)	Ninety (90) days	Not Applicable

During the "Labor" warranty period there will be no charge for labor. During the "Parts" warranty period, there will be no charge for parts. You must carry-in or mail-in your product during the warranty period. If non-rechargeable batteries are included, they are not warranted. This warranty only applies to products purchased and serviced in the United States or Puerto Rico. This warranty is extended only to the original purchaser of a new product which was not sold "as is". A purchase receipt or other proof of the original purchase date is required for warranty service.

### Carry-In or Mail-In Service

For Carry-In or Mail-In Service in the United States call 1-800-211-PANA (1-800-211-7262) or visit Panasonic web site: <http://www.panasonic.com>  
For assistance in Puerto Rico call Panasonic Sales Company (787)-750-4300 or fax (787)-768-2910.

### Limited Warranty Limits And Exclusions

This warranty ONLY COVERS failures due to defects in materials or workmanship, and DOES NOT COVER normal wear and tear or cosmetic damage. The warranty ALSO DOES NOT COVER damages which occurred in shipment, or failures which are caused by products not supplied by the warrantor, or failures which result from accidents, misuse, abuse, neglect, mishandling, misapplication, alteration, faulty installation, set-up adjustments, misadjustment of consumer controls, improper maintenance, power line surge, lightning damage, modification, or commercial use (such as in a hotel, office, restaurant, or other business), rental use of the product, service by anyone other than a Factory Servicenter or other Authorized Servicer, or damage that is attributable to acts of God.

**THERE ARE NO EXPRESS WARRANTIES EXCEPT AS LISTED UNDER "LIMITED WARRANTY COVERAGE". THE WARRANTOR IS NOT LIABLE FOR INCIDENTAL OR CONSEQUENTIAL DAMAGES RESULTING FROM THE USE OF THIS PRODUCT, OR ARISING OUT OF ANY BREACH OF THIS WARRANTY.** (As examples, this excludes damages for lost time, travel to and from the servicer, loss of media or images, data or other memory content. The items listed are not exclusive, but are for illustration only.) **ALL EXPRESS AND IMPLIED WARRANTIES, INCLUDING THE WARRANTY OF MERCHANTABILITY, ARE LIMITED TO THE PERIOD OF THE LIMITED WARRANTY.**

Some states do not allow the exclusion or limitation of incidental or consequential damages, or limitations on how long an implied warranty lasts, so the exclusions may not apply to you. This warranty gives you specific legal rights and you may also have other rights which vary from state to state. If a problem with this product develops during or after the warranty period, you may contact your dealer or Servicenter. If the problem is not handled to your satisfaction, then write to the warrantor's Consumer Affairs Department at the addresses listed for the warrantor.

**PARTS AND SERVICE WHICH ARE NOT COVERED BY THIS LIMITED WARRANTY ARE YOUR RESPONSIBILITY.**

## Customer Services Directory

**For Product Information, Operating Assistance, Literature Request, Dealer Locations, and all Customer Service inquiries please contact:  
1-800-211-PANA (7262), Monday-Friday 9 am-9 pm; Saturday-Sunday 9 am-7 pm, EST.  
or send e-mail:  
[consumerproducts@panasonic.com](mailto:consumerproducts@panasonic.com)  
For hearing or speech impaired TTY users, TTY: 1-877-833-8855**

**Web Site: <http://www.panasonic.com>  
You can purchase parts, accessories or locate your nearest servicenter by visiting our Web Site.**

### Accessory Purchases:

1-800-332-5368 (Customer Orders Only)  
For hearing or speech impaired TTY users, TTY: 1-866-605-1277  
Panasonic Services Company 20421 84th Avenue South, Kent, WA 98032  
(6 am to 5 pm Monday-Friday; 6 am to 10:30 am Saturday; PST)  
(Visa, MasterCard, Discover Card, American Express, Check)

**Service in Puerto Rico  
Matsushita Electric of Puerto Rico, Inc. Panasonic Sales Company/Factory Servicenter:  
Ave. 65 de Infantería, Km. 9.5, San Gabriel Industrial Park, Carolina, Puerto Rico 00985  
Phone (787) 750-4300 Fax (787) 768-2910**

## Listening caution



Selecting fine audio equipment such as the unit you've just purchased is only the start of your musical enjoyment. Now it's time to consider how you can maximize the fun and excitement your equipment offers. This manufacturer and the Electronic Industries Association's Consumer Electronics Group want you to get the most out of your equipment by playing it at a safe level. One that lets the sound come through loud and clear without annoying blaring or distortion—and, most importantly, without affecting your sensitive hearing.

We recommend that you avoid prolonged exposure to excessive noise.

Sound can be deceiving. Over time your hearing "comfort level" adapts to higher volumes of sound. So what sounds "normal" can actually be loud and harmful to your hearing.

Guard against this by setting your equipment at a safe level BEFORE your hearing adapts.

To establish a safe level:

- Start your volume control at a low setting.
- Slowly increase the sound until you can hear it comfortably and clearly, and without distortion.

Once you have established a comfortable sound level:

- Set the dial and leave it there.

Taking a minute to do this now will help to prevent hearing damage or loss in the future. After all, we want you listening for a lifetime.

Manufactured under license from Dolby Laboratories. "Dolby", "Pro Logic" and the double-D symbol are trademarks of Dolby Laboratories.

Manufactured under license from Digital Theater Systems, Inc. US Pat. No. 5,451,942, 5,956,674, 5,974,380, 5,978,762 and other world-wide patents issued and pending. "DTS" and "DTS Digital Surround" are registered trademarks of Digital Theater Systems, Inc. © 1996, 2000 Digital Theater Systems, Inc. All rights reserved.

Apparatus Claims of U.S. Patent Nos. 4,631,603, 4,577,216, and 4,819,098, licensed for limited viewing uses only.

This product incorporates copyright protection technology that is protected by method claims of certain U.S. patents and other intellectual property rights owned by Macrovision Corporation and other rights owners. Use of this copyright protection technology must be authorized by Macrovision Corporation, and is intended for home and other limited viewing uses only unless otherwise authorized by Macrovision Corporation. Reverse engineering or disassembly is prohibited.

For U.S.A.



As an ENERGY STAR® Partner, Panasonic has determined that this product meets the ENERGY STAR® guidelines for energy efficiency.

**Panasonic Consumer Electronics Company, Division of Matsushita Electric Corporation of America**

One Panasonic Way Secaucus,  
New Jersey 07094  
<http://www.panasonic.com>

**Panasonic Sales Company, Division of Matsushita Electric of Puerto Rico, Inc. ("PSC")**

Ave. 65 de Infantería, Km. 9.5  
San Gabriel Industrial Park, Carolina,  
Puerto Rico 00985

**Panasonic Canada Inc.**

5770 Ambler Drive  
Mississauga, Ontario  
L4W 2T3  
[www.panasonic.ca](http://www.panasonic.ca)



© 2003 Matsushita Electric Industrial Co., Ltd.

Printed in Singapore

RQT6719-P  
F0103MF0